

NOTICE DE MONTAGE

ABRI ALPINA

Réf. AL 3019.02 N

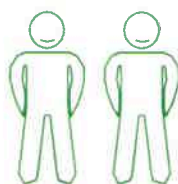
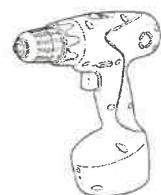
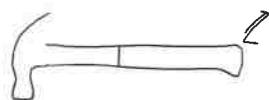
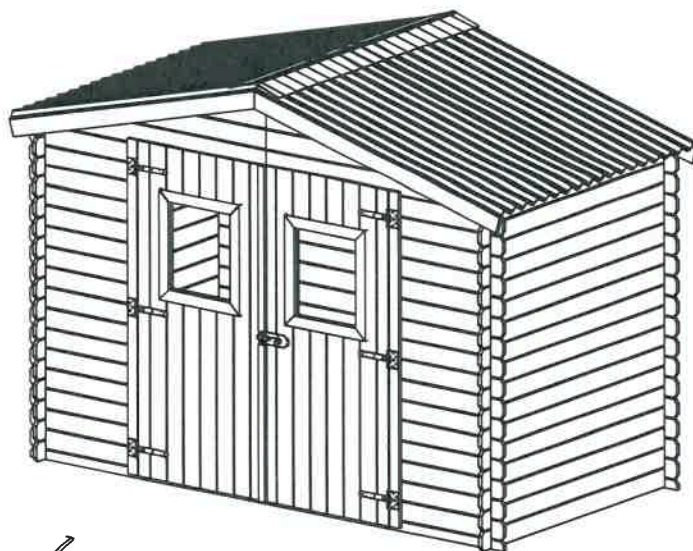
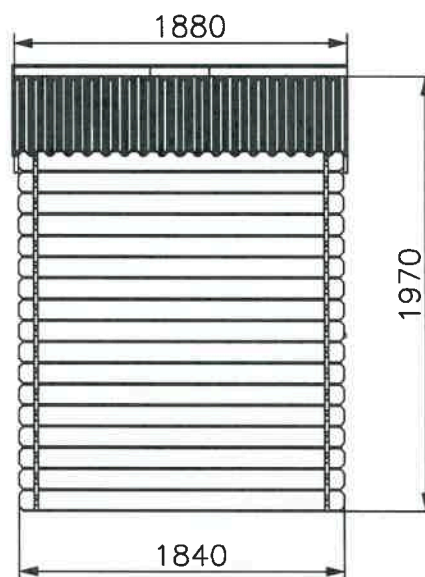
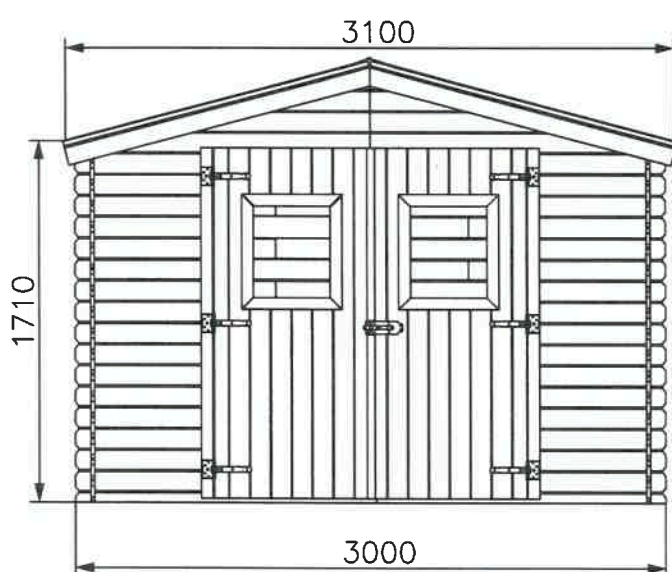

Les dimensions données sur le plan de soubassement sont les dimensions de la dalle béton à réaliser sur un sol parfaitement plat sans aucun autre objet extérieur type mur, clôture ou arbre dans l'entourage de la dalle. Si le produit est implanté près d'un mur, d'une haie ou d'un arbre il est nécessaire de l'éloigner des éléments extérieurs afin de pouvoir facilement le monter et l'entretenir. Nous nous dégageons de toute responsabilité en cas de mauvaise interprétation des dimensions de la dalle.

































Le dimensioni del piano di base sono le dimensioni della soletta di cemento da realizzare su un terreno perfettamente piatto, senza alcun altro oggetto esterno, come un muro, una recinzione o un albero in prossimità delle solette. Se il prodotto è installato vicino ad una parete, un recinto o un albero, è necessario distanziarlo adeguatamente, in modo da poterlo facilmente montare e farne la manutenzione. Non ci assumiamo alcuna responsabilità per l'errata interpretazione delle dimensioni delle lastra.

NOTICE DE MONTAGE**ABRI ALPINA**Réf. **AL 3019.02 N**

Nous garantissons la fourniture des pièces détachées durant 2 ans à compter de l'achat du produit.

Vérifier que vous avez bien toutes les pièces avant d'effectuer le montage

Demande sav

N°	Qté.	Dessin pièce	Réf.	Dimensions (en mm)			Observation	Qté.
1	4		I20.1.1520	20	61	1520		
2	15		L20.1.2000	20	107	2000		
3	15		L20.1.1040	20	107	1040		
4	2		L20.1.1520	20	107	1520		
5	32		L20.2.1840	20	107	1840		
6	2		LS20.2.1840	40	107	1840		
7	32		L20.1.655	20	107	655		
8	6		GL1840.70	40	70	1840		
9	1		TLD1690.20	60	70	1690		
10	1		TLS1690.20	60	70	1690		
11	1		EST1680.40	20	40	1680		
12	2		ELT70.200	20	70	200		
13	4		DSF1600.90	20	90	1600		
14	2		R150.90	20	90	150		
15	1		SUV40.810	20	40	810		
16	1		SUV40.810	20	40	810		
17	2		SFD20.1500.300	40	300	1500		
18	2		SFS20.1500.300	40	300	1500		
19	1		UD1690.800	40	800	1690		
20	1		US1690.800	40	800	1690		
21	2		OSB12.200	12	180	200		
22	4+2		OND998.860+430	30	998	860+430		
23	4+2		OND664.860+430	30	664	860+430		
24	2		FOND360.1000	30	360	1000		
Q1	6		VIS4.20		4	30		
Q2	16		VIS5.70		3,5	35		
Q3	86		VIS4.40		4	40		
Q4	32		CLO.SHI16		4	16		
Q5	54		CLO.OND60		2,2	60		
Q6	20		VIS3.30		3	30		
Q7	1		LOQ.EXT					
Q8	2		LOQ.INT					
Q9	6		CHAR.150					

A compléter impérativement pour toute demande SAV et à envoyer par mail à sav@foresta.fr + photo des pièces abîmées

 <p>Colis n°: _____</p>	<p>AL 3019.02N</p> <p>Colis n°: _____</p>	NOM DU MAGASIN (où l'abri a été acheté)	
		NOM DU CLIENT	
		PRENOM DU CLIENT	
		N° de téléphone	

NOTICE DE MONTAGE **ABRI ALPINA**

Réf. **AL 3019.02 N**

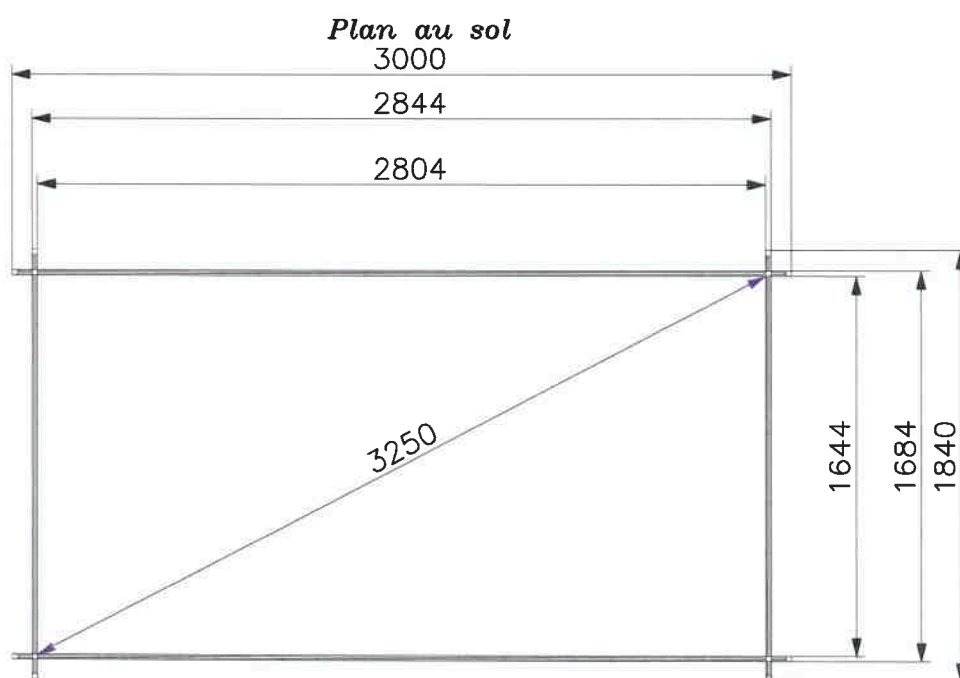

Plan de soubassement

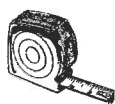
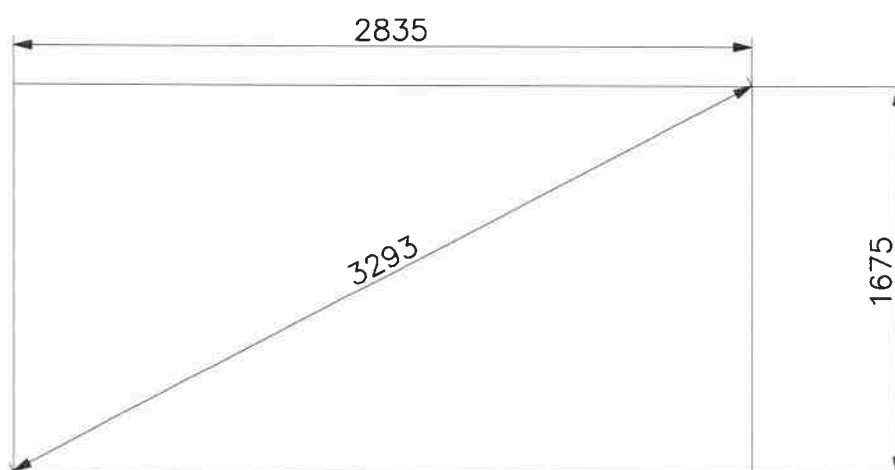

Tolérances à respecter (selon DTU 31.2):

- longueur et largeur: + 0,01m;
- équerrage: +0,01m mesuré sur 10m;
- arase: +0,01m sur une longueur de 10 mètres linéaires alignés ou non et de + 2mm par mètre linéaire;
- rectitude de bords en plan: +5mm .

ABRI ALPINA

Réf. **AL 3019.02 N**

Paroi facade, vue extérieure

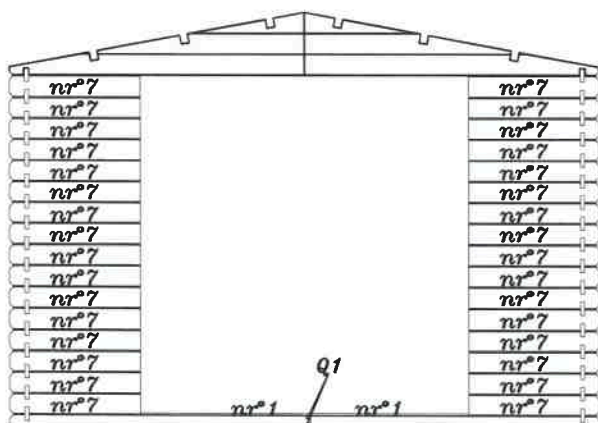

Nr°.	Qté.	Dimensions (mm)		
1	2	20	61	1520
7	32	20	107	655
17	1	40	300	1500
18	1	40	300	1500
Q1	2		ø6	30

Paroi arrière, vue extérieure

Nr°.	Qté.	Dimensions (mm)		
1	2	20	61	1520
2	15	20	107	2000
3	15	20	107	1040
4	2	20	107	1520
17	1	40	300	1500
18	1	40	300	1500
Q1	2		ø6	30

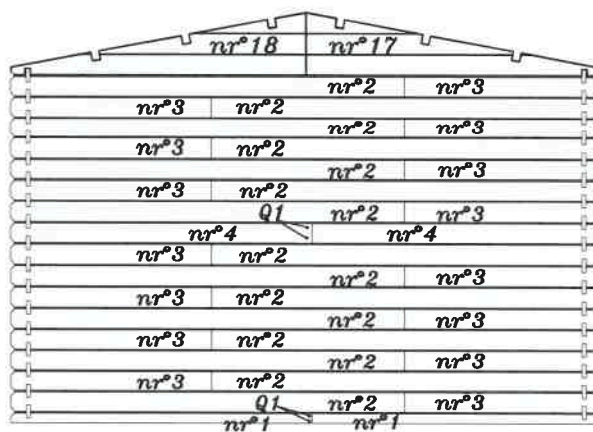

Paroi latérale gauche, vue extérieure

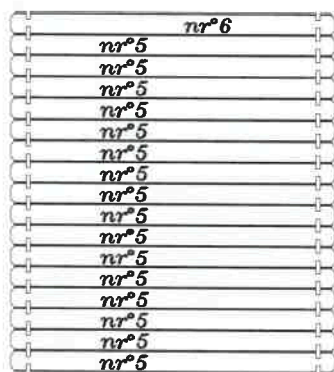

Nr°.	Qté.	Dimensions (mm)		
5	16	20	107	1840
6	1	40	107	1840

Paroi latérale droite, vue extérieure

Nr°.	Qté.	Dimensions (mm)		
5	16	20	107	1840
6	1	40	107	1840

NOTICE DE MONTAGE

ABRI ALPINA

Réf. AL 3019.02 N

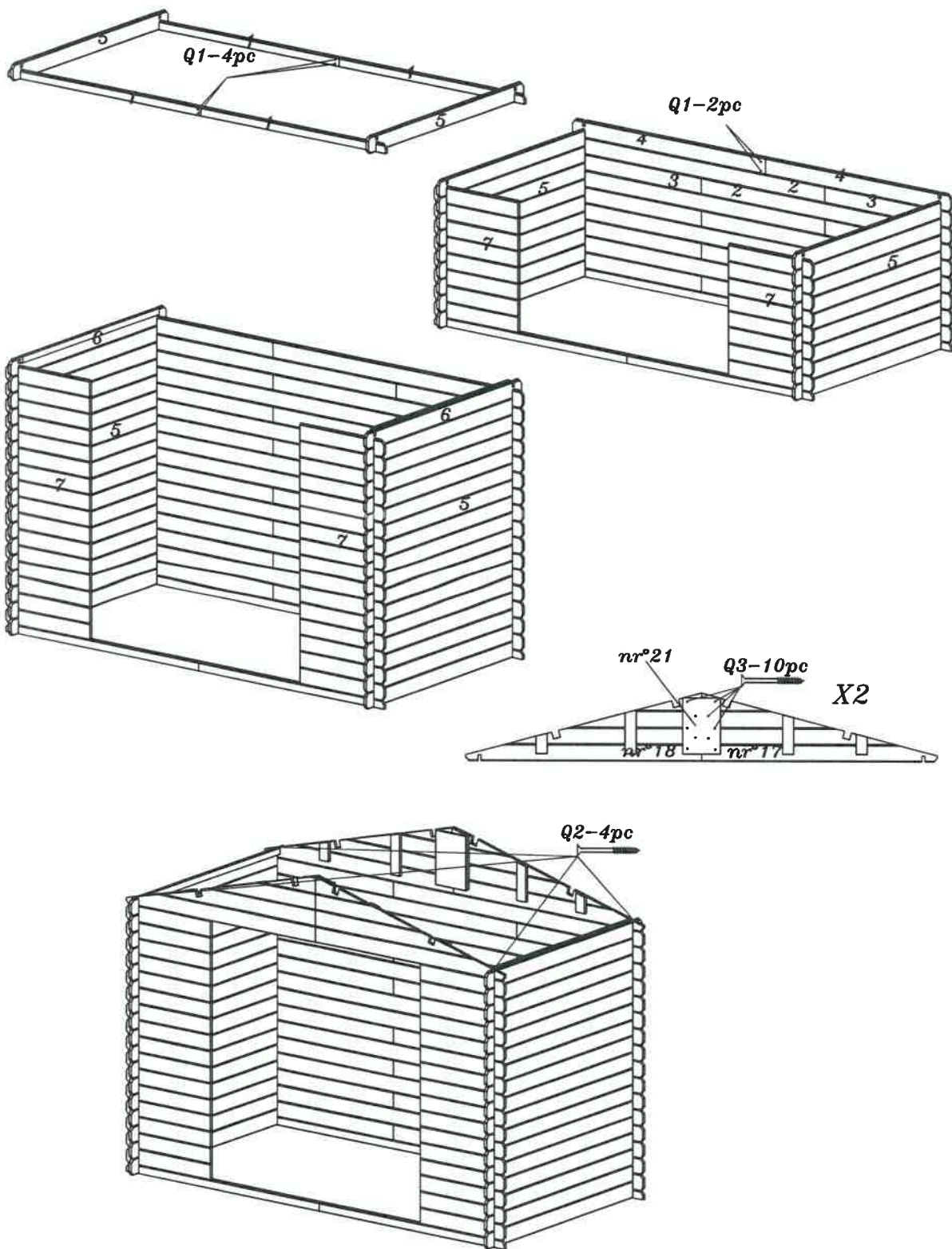

NOTICE DE MONTAGE

ABRI ALPINA

Réf. AL 3019.02 N

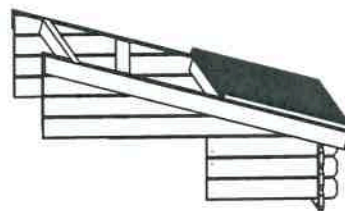
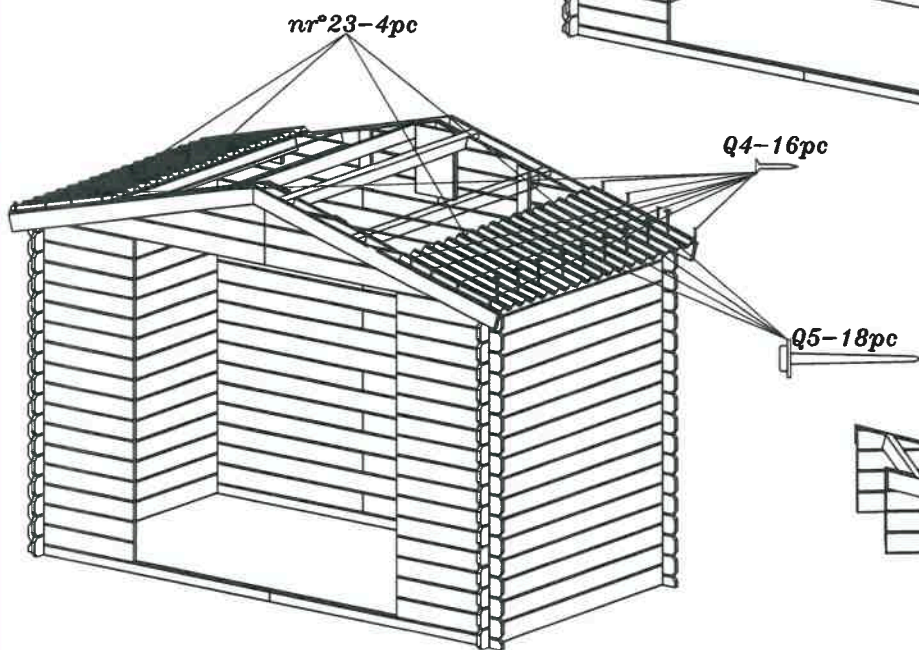
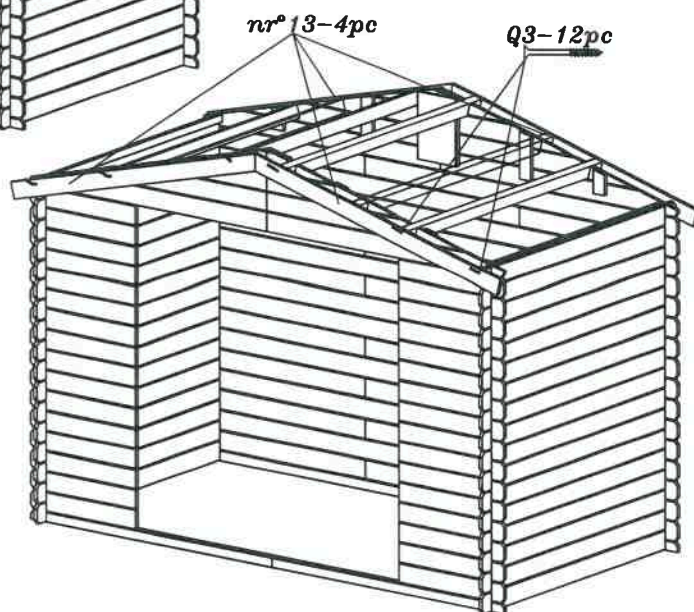
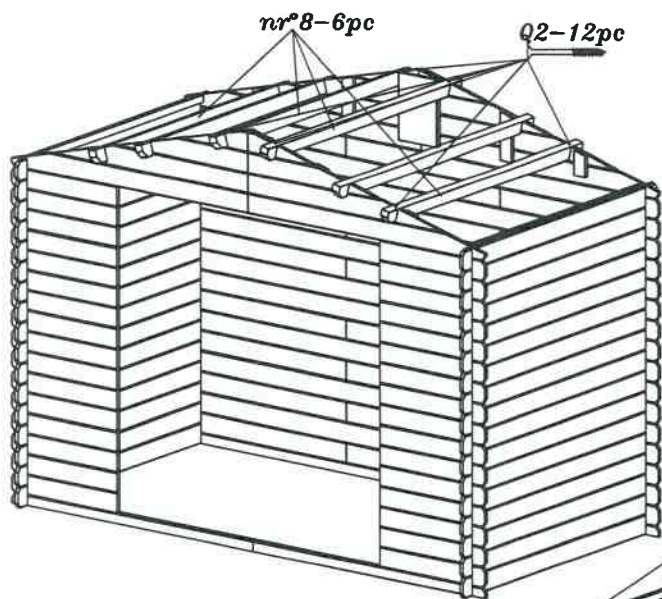

NOTICE DE MONTAGE **ABRI ALPINA**
Réf. **AL 3019.02 N**

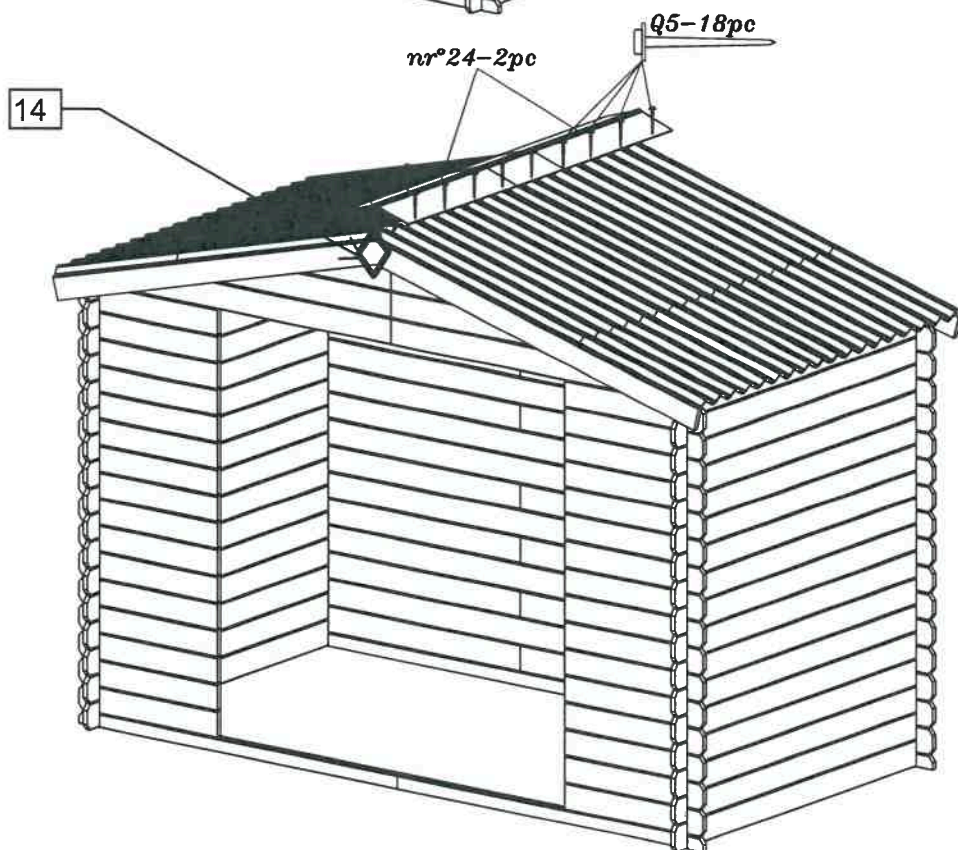
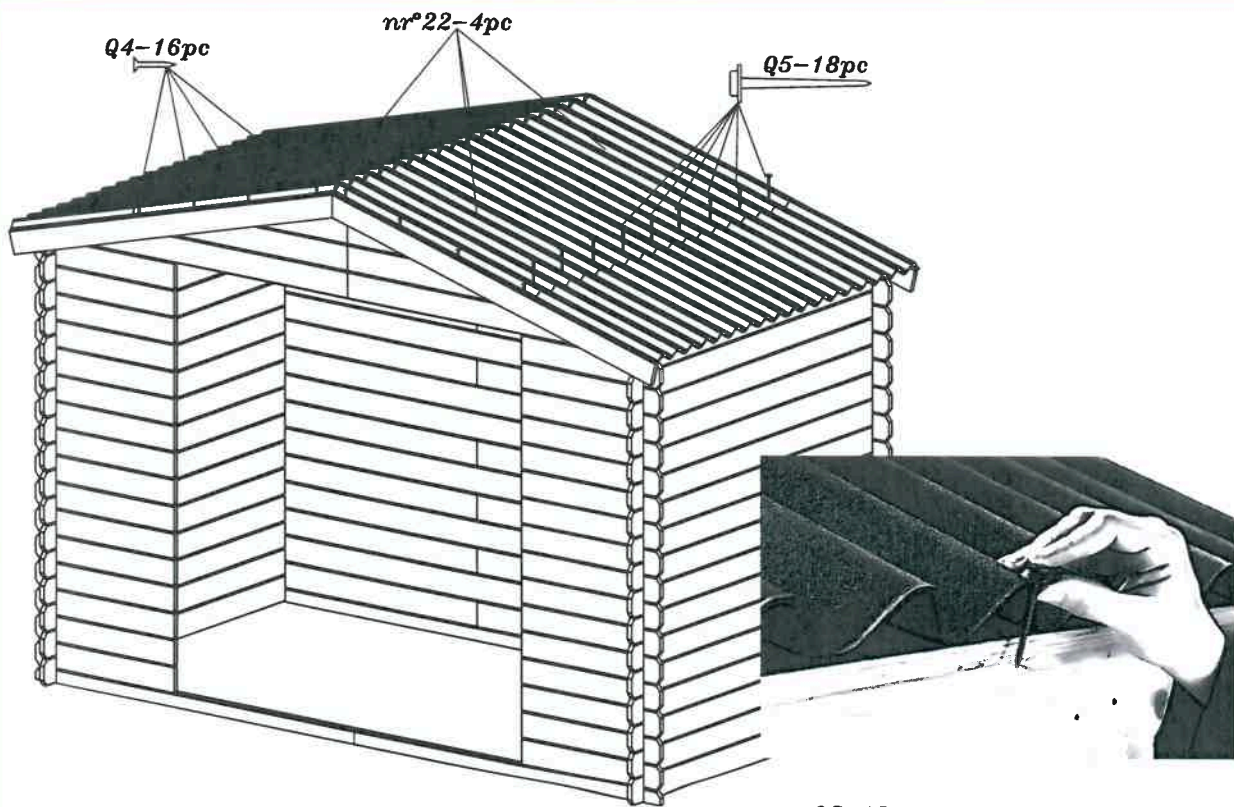

NOTICE DE MONTAGE

ABRI ALPINA

Réf. AL 3019.02 N

Vue extérieure

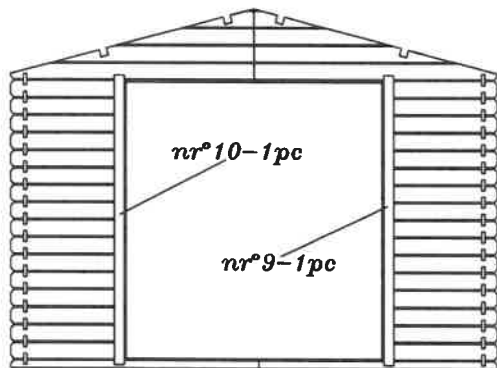

Vue intérieure

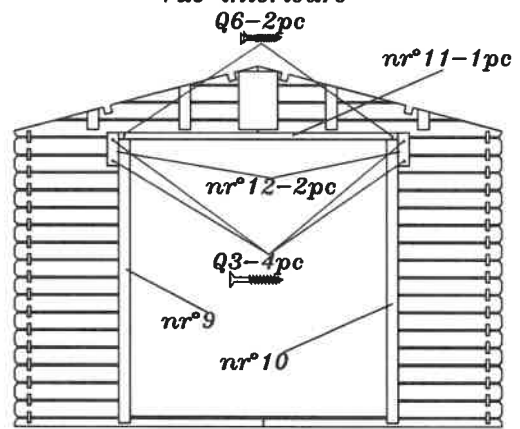

Vue extérieure

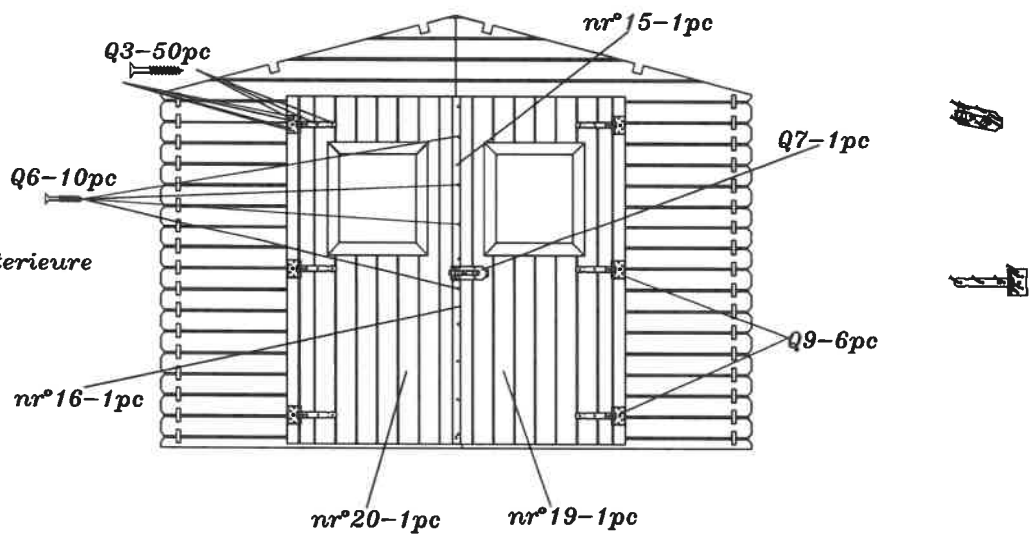

Vue intérieure

