















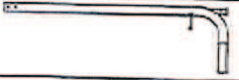













Number	Instruction	Qty	Number	Instruction	Qty
1		2	12		1
2		2	13		2
3		1	14		2
4		1	15		2
5A		4	16	 M6*68	2
5B			17	 M8*112	4
6		1	18	 M6*40	2
			19	 M6*80	4
			20	 M5*20	2
7		2	21	 M6*45	2
8		2	22	 M5*28	1
9		1	23		1
10		1	24		1
			25	 M6*72	2
11		2			

a

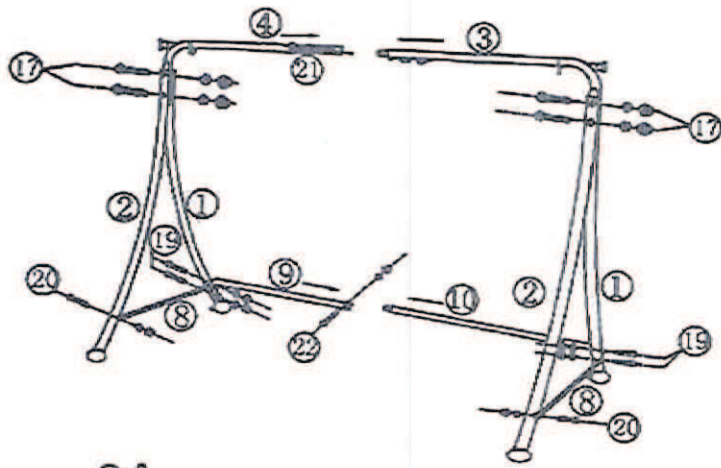

b

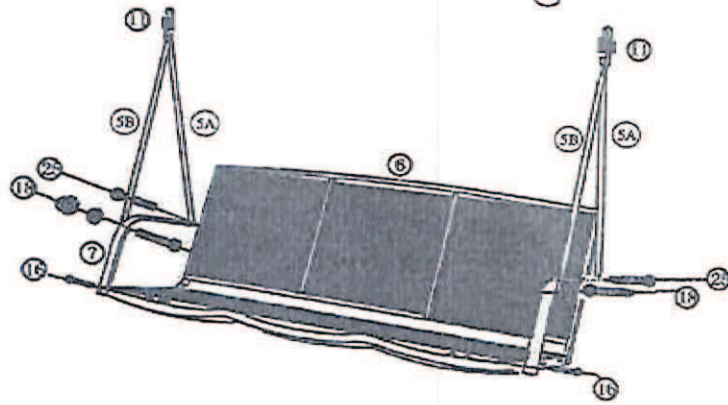

c

