

Shelty +

18m²



Version 1- 11/01/2019

A lire avant le montage afin de profiter pleinement de votre abri Cerland

Vous venez de recevoir votre abri Cerland et nous espérons que ce produit vous apportera entière satisfaction.

L'abri que vous venez de recevoir est en bois d'épicéa du nord. Le bois ne se fabrique pas, c'est une matière organique naturelle, unique, qui inspire son charme grâce à ses imperfections. Nœuds et fissures ne sont pas des défauts mais une particularité de cette noble matière. Le bois continue à évoluer et à se teindre dans le temps. Il est susceptible de gonfler légèrement pendant les périodes hivernales et de se rétracter en périodes sèches. Ces variations dimensionnelles sont tout à fait normales et prévisibles et ne remettent pas en cause la solidité, la stabilité et la fonctionnalité du produit.

Préambule du montage :

- Afin de garantir la durabilité de votre abri, celui-ci doit être monté sur une dalle béton plane et de niveau, aux dimensions adaptées (dimension au sol + 2cm, n'excédant pas les dimensions hors tout de l'abri) afin d'éviter toute retenue d'eau et une bonne évacuation de celle-ci, isolée du sol afin d'éviter les remontées d'humidité et réalisée suivant les règles de l'art (avec par exemple une membrane étanche). L'emplacement de votre abri doit être étudié afin que celui-ci ne soit pas exposé au vent dominant.
- Avant de monter votre abri, veuillez laisser votre colis à l'abri des intempéries.
- Avant de commencer le montage, veuillez faire un inventaire complet des pièces.
- L'abri est en bois séché brut, c'est-à-dire qu'il n'a subi aucun traitement protecteur. Avant le montage, il faut donc traiter les composants bois un à un sur toutes les faces avec un produit de protection insecticide et fongicide. Veuillez à respecter les recommandations du produit appliqué (application, séchage, etc...) Le séchage doit se faire impérativement à plat afin d'éviter toutes déformation des composants.
- Une fois l'abri monté, appliquez deux couches de lasure microporeuse hydrofuge et anti-UV, à l'extérieur et à l'intérieur de l'abri. Veuillez à respecter les recommandations du produit appliqué (application, séchage, etc...)
- Surface à traiter de l'abri : 60m²

Ce produit doit être monté par au moins deux personnes. Le temps de montage estimatif est d'une journée.

Spécificité de la toiture :

- L'abri que vous venez de recevoir possède une toiture en métal, moderne, durable et esthétique. Il s'agit d'acier traité. Il convient de les manipuler avec attention afin de ne pas endommager le traitement lors du montage. S'il y a nécessité de marcher dessus ou de s'appuyer dessus lors du montage, utiliser des chaussures à semelles souples en posant les pieds au creux des vagues. Avant de prendre appui, toutes les vis doivent être vissées. Pour assurer la sécurité, les appuis doivent être pris au niveau des pannes.
- Les copeaux métalliques provenant des perçages doivent être éliminés à l'aide d'une brosse douce, car en rouillant ils peuvent altérer le revêtement.

- La toiture a été spécialement étudiée pour l'abri et ne nécessite aucune découpe ou mise en œuvre particulière.
- L'outil recommandé pour le vissage de la toiture est la perceuse-visseuse. La vitesse de rotation recommandée est de 1800trs/min au maximum, serrage 3Nm avec embout à vis hexagonal 8mm.

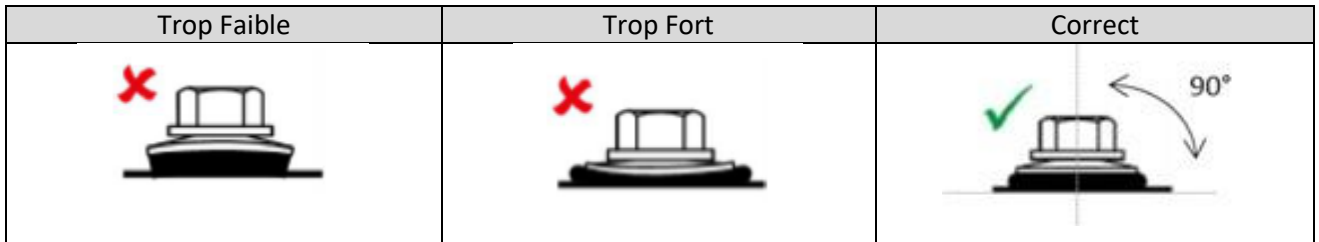

Entretien de votre produit :

- La toiture ne nécessite pas d'entretien particulier. Il est seulement nécessaire d'enlever les feuilles qui en pourrissant peuvent décolorer les revêtements.
- Suivant les préconisations du producteur de lasure et le vieillissement de votre produit, vous pouvez lasurer de nouveau votre abri. Il convient d'entretenir le bois de l'abri 1 fois par an.
- Lubrifier la serrure et graisser les charnières de porte et de fenêtre et les loquets 1 fois par ans.
- La toiture de l'abri a été conçue pour résister à la charge de neige (75kg/m²). Il est cependant recommandé de dégager régulièrement la neige afin d'éviter toute surcharge.
- En cas d'impacts sur la toiture avec détérioration du revêtement, il faut appliquer de l'antirouille localement pour protéger la toiture.

Service après-vente :

- Malgré tout le soin apporté à la conception, à la fabrication et à la livraison de votre abri, un service après-vente est assuré en cas de remarque ou de besoin. Vous pouvez contacter votre revendeur en vous munissant de la fiche de contrôle qualité jointe à cette notice pour toute demande.
- Votre produit est garanti suivant les conditions générales de vente à partir de la date d'achat. Un justificatif d'achat avec date doit être fourni pour toute prise en compte.
- Le bois étant un matériau vivant, certaines particularités sont acceptables comme: nœuds, décoloration, fentes droites, fentes de séchage car elles n'altèrent pas la qualité du produit, torsions et voilages si l'assemblage reste possible, nœuds non adhérents, poches de résine, toute évolution naturelle relative au matériau du bois. Notre garantie se limite à la réparation ou au remplacement de la pièce défectueuse. Les éventuels frais de pose, de dépose et de traitement ne sont pas pris en charge. La garantie n'implique en aucun cas une demande d'indemnités ou de dommages - intérêts. Pour les livraisons à domicile, les réclamations concernant l'état des marchandises livrées ne sont recevables que si elles sont formulées par écrit recommandé dans les 48h de leur arrivée auprès du transporteur concerné (coordonnées de celui-ci sur la lettre de voiture). Nous ne pouvons être tenus responsables d'un dommage lié au stockage ou au transport effectué par le revendeur ou le client en cas de livraison LDD. Nous ne sommes pas tenus de reprendre un matériel neuf qui nous serait retourné pour un motif ne relevant pas de notre responsabilité, si une reprise exceptionnelle était consentie, les frais éventuels de remise en état et des frais d'expédition pourraient être facturés.

- La garantie ne couvre pas : l'utilisation abusive du produit, utilisation du produit à des fins professionnelles, utilisation non adaptée à la fonction première du produit, modification de tout ou partie du produit ou de l'un de ses composants, utilisation de pièces de rechange qui ne seraient pas d'origine, utilisation du produit dans des « conditions non raisonnablement prévisibles d'utilisation » ; Elle ne couvre pas les défauts de stockage, de montage ainsi que l'insuffisance de traitement protecteur et les défauts induits par une mauvaise planéité du sol.

Shelty + de Cerland, une nouvelle gamme construite pour durer

To read before assembly to take full advantage of your new Cerland shed

You just received your Cerland shed and we wish that this product will bring you entire satisfaction.

This shed is made out of northern spruce wood. Wood cannot be industrially created, it's a natural organic material, unique, which inspires its charm thanks to its imperfections. Knots and cracks are not defects but particularities of this noble material. Wood continue to evolve and dye over time. It is likely to swell slightly during winter periods because of humidity and retract during dry periods. These dimensional variations are quite normal and predictable and do not affect the strength, stability and functionality of the product.



Assembly preamble:

- In order to guarantee the durability of your shed, it must be mounted on a flat and level concrete slab, with appropriate dimensions (shed ground dimension +2cm, not exceeding shed over all dimension) in order to avoid any water retention. It must be isolated from the ground to prevent moisture rise and built according to rules of execution (with waterproof membrane for example). The position of the shed must be studied to not expose it to the prevailing wind.
- Before the assembly, leave your package protected from bad weather.
- Before you start the assembly, make a complete inventory of the parts.
- The shed is in natural dry wood that is free from any protective treatment. Before the assembly, wood components must be treated one by one on all sides with an insecticide and fungicide protection. Make sure to respect the recommendations of the applied product (application, drying, ...) The drying must imperatively be done flat to avoid any deformation of the parts.
- Once the shed is mounted, apply two layers of water-repellent and UV-resistant microporous stain outside and inside the shed. Make sure to respect the recommendations of the applied product (application, drying,...)
- Surface to be treated and stain : 60m²

This product must be mounted by at least two persons. The estimated assembly time is one day.

Roof specifications:

- The shed you received has a metallic roof, modern, durable and aesthetic. The tiles are steel treated. They should be handled with care to avoid any damage on treated surface. If it is necessary to step on or lean on it during assembly, use soft-soled shoes and place your feet in the deep of the waves. Before doing this, check that all the screws are screwed. To ensure security, you should lean on beams level.
- The metal chips from drilled holes made on tiles must be removed with a soft brush, because while rusting, they can damage the treatment of the tiles.
- The roof has been specially designed for this shed and requires no cutting or special implementation.
- The recommended tool for screwing the roof is the drill-screw-gun. The recommended rotation speed is 1800 rpm max, tightening 3Nm with 8mm hex screw head.

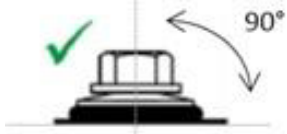
Too weak	Too Strong	Correct
		

Shed maintenance:

- The roof does not require any particular maintenance. It is only necessary to remove the leaves which in rotting can discolor the coating of the tiles.
- Following the recommendations of the producer of stain and the aging of your product, you can stain again your shed. The shed wood should be treated once a year.
- Lubricate the lock and grease the door hinges and the latches once a year.
- The roof of the shed has been designed to withstand the snow load (more than 75Kg/m²). However, it is recommended to remove the snow regularly to avoid overload.
- In case of impacts on the roof tiles with deterioration of the coating, it is necessary to apply antirust locally to protect the roof.







After sales service:



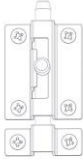
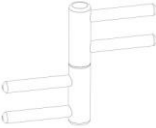

- Despite all the care taken in the design, manufacture and delivery of your shed, after sale service is provided in case of remark or need. You can contact your local dealer with the quality control sheet attached to this manual for any request.
- Your product is guaranteed according to the general conditions of sale from the date of purchase. A proof of purchase with date must be provide for any after sale service consideration.
- The wood is a living material, some features are acceptable such as: knots, discoloration, straight slits, drying slits because they do not affect the quality of the product, twists and wraps if the assembly remains possible, non-adherent knots, pockets of resin, and any natural evolution relative to the wood material. Our guarantee is limited to repairing or replacing the defective part. Possible installation, removal and processing costs are not supported. The guarantee does not imply a claim for compensation. For deliveries at home, complaints concerning the condition of the goods delivered are only admissible if they are formulated by writing within 48 hours of their arrival to the carrier concerned. We cannot be held responsible for damage related to the storage or the transport carried out by the retailer or the customer himself. We are not required to take back any new equipment returned to us for any reason that is not our responsibility, if an exceptional recovery is granted, any costs of refurbishment and shipping costs may be charged.
- The guarantee does not cover: misuse of the product, use of the product for professional purposes, use not adapted to the primary function of the product, modification of all or part of the product or of its components, use of spares parts that are not original, use of the product under “condition not reasonably foreseeable for use”. It does not cover the defects of storage, of assembly as well as the insufficiency of protective treatment or stain and the defects induced by a bad flatness of the ground.

Cerland Shelty +, a new range designed to last





Blister

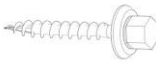

S03714

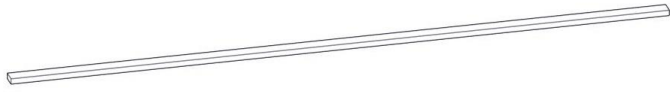

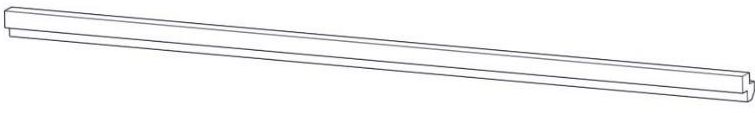

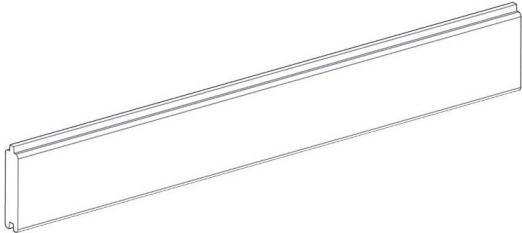
Code	Name	Visual	Quantity
H1	Lock		4
H2	Door hinges		6
H3	Handle		1
H4	Motrice Lock		1
H5	Windows hinges		2
H6	Limitator		2
H7	Nail D2x30		210

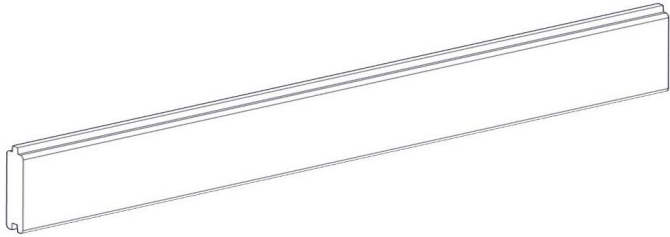
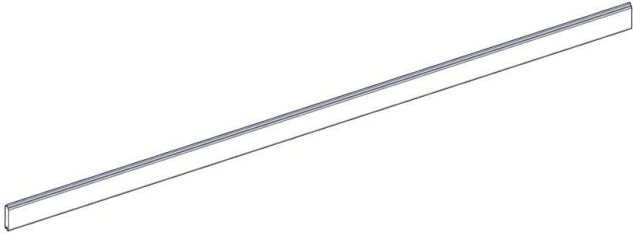
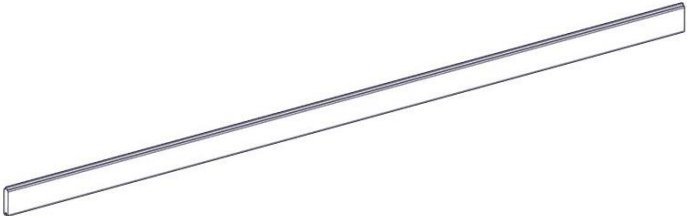
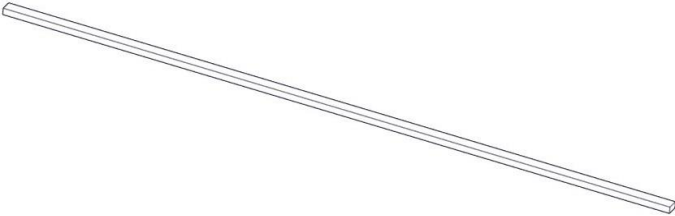
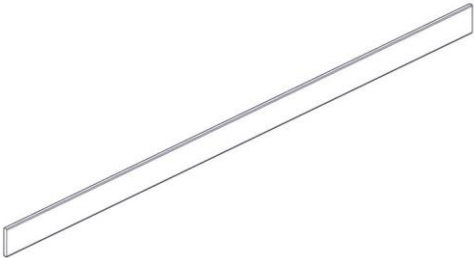

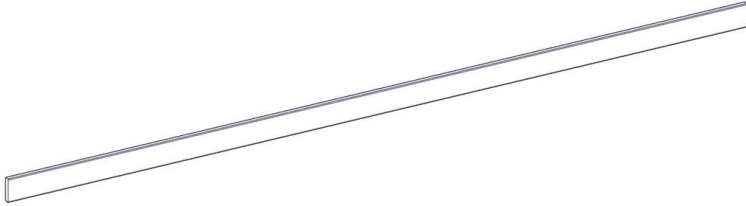
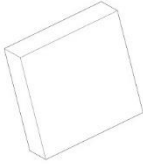

H8	Screw D4x35		373
H9	Screw D4x50		446
H10	Screw D4x70		32
H11	Screw D4x120		4
H12	Screw for roof		164

Composition

Code	Name Size SAV code	Visual	Quantity
LA1	LA1 28x70x4480 S03761		2
LA2	LA2 28x70x3810 S03757		2
PO	PO 70x70x1980 S03718		4
PA	PA 47x96x3894 S03756		8
MA1	MA1 28x119x333 S03763		28

MA2	MA2 28x119x1408 S03764		20
MA3	MA3 28x119x3866 S03743		36
MA4	MA4 28x119x4396 S03762		17+1
LR	LR 19x35x1978 S03726		9
PF1	PF1 19x90x2383 S03766		4
PF2	PF2 19x90x1980 S03729		8

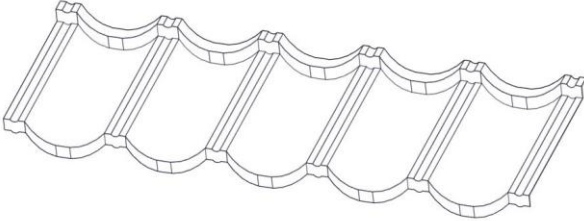
PF3	PF3 19x45x1817 S03732		1
PF4	PF4 19x90x3988 S03759		2
Dist.	Distance 19x70x70 S03731		16+4
Gable	Gable S03767		2
Door frame	Door frame S03734		1
Door left	Door left S03735		1

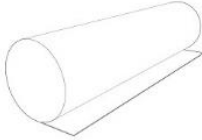
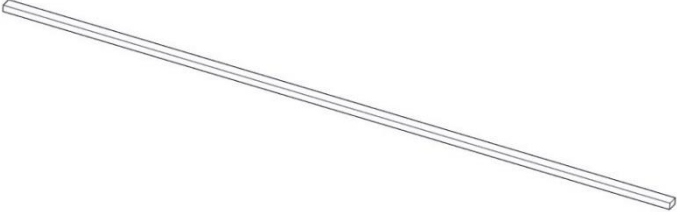
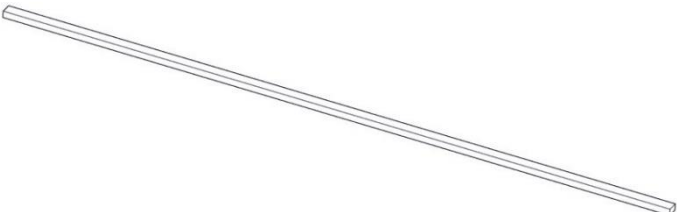
Door right	Door right S03736		1
Window	Window S03748		2
Tiles	Tiles S03737		56
Ridge tiles	Ridge tiles S03760		2
Fin. tiles	Finishing tiles S03768		4
	Pare vapeur		1
Liteau	LT1 19x35x2325 S03765		16
Liteau	LT2 19x35x33948 S03758		14

Overview

18m²

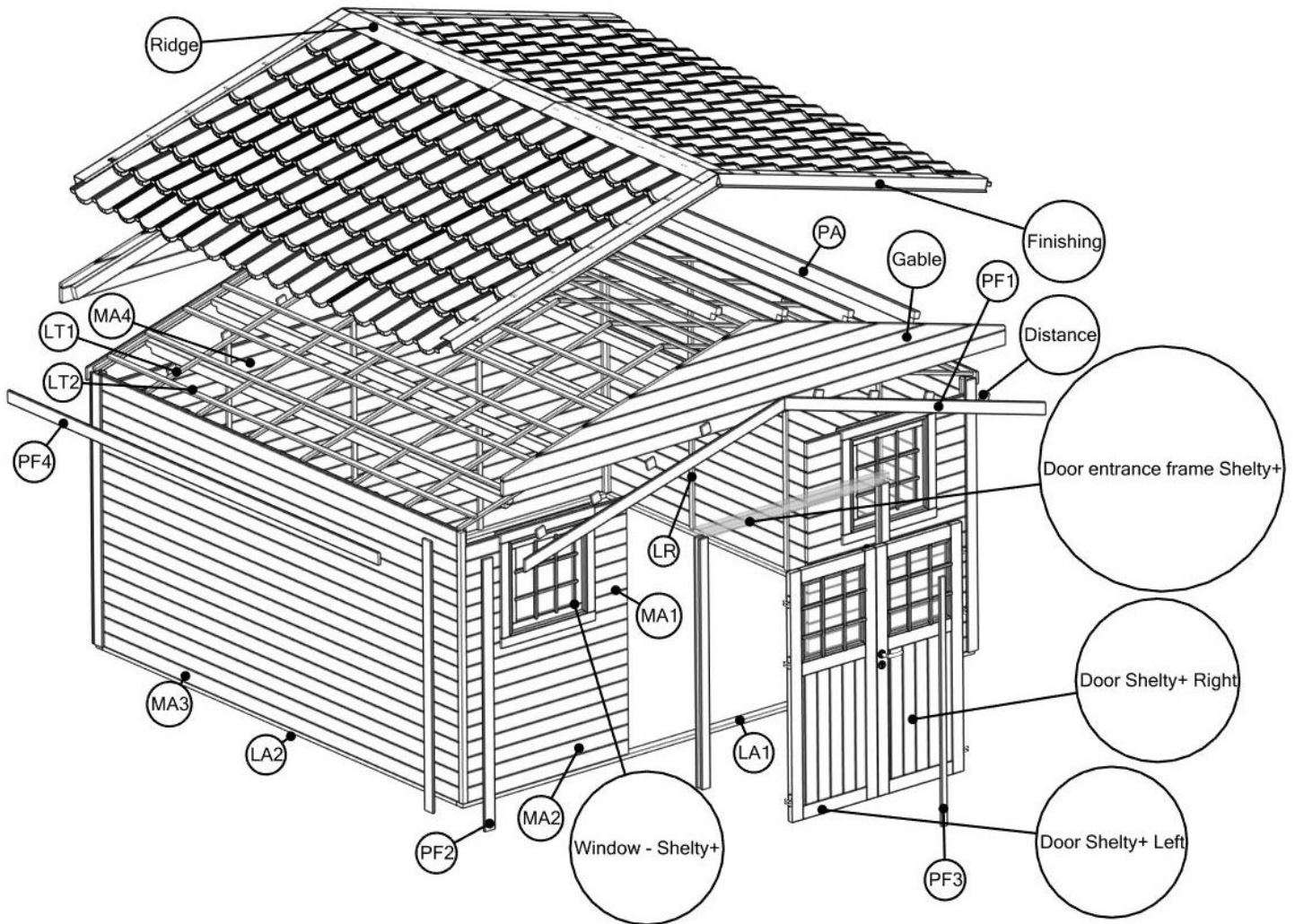

1/61

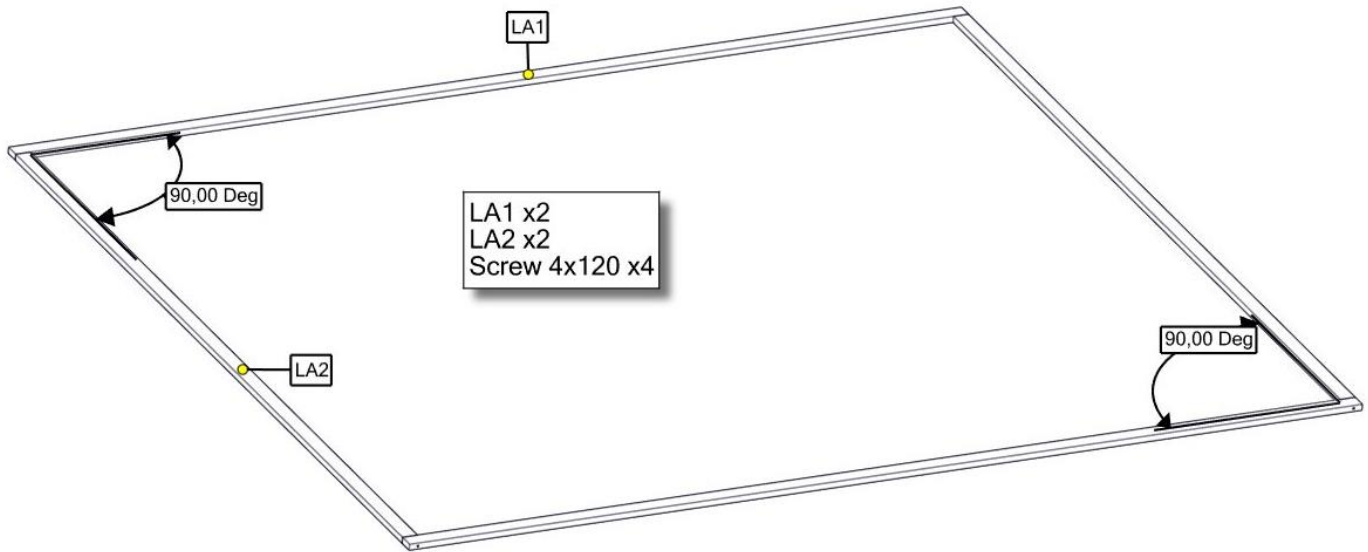

2/61

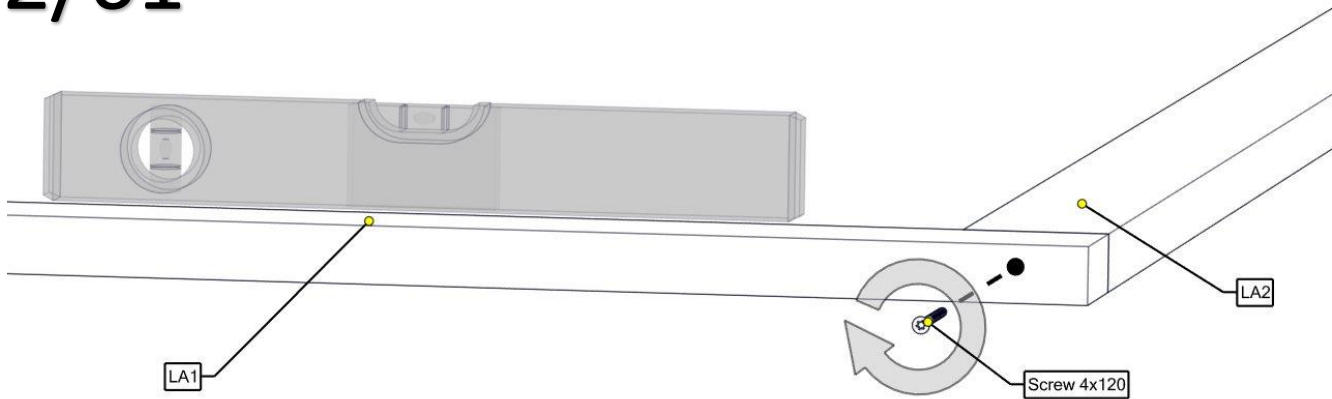

3/61

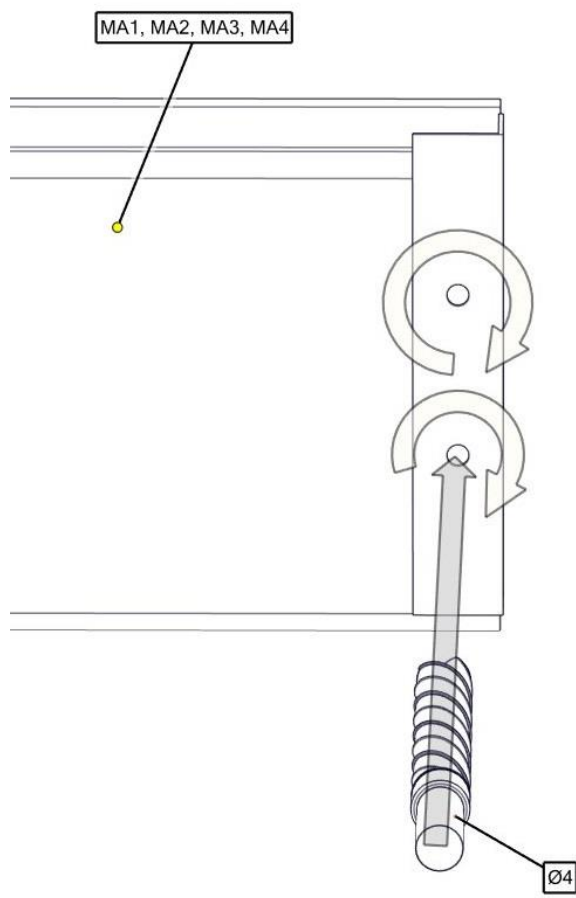

4/61

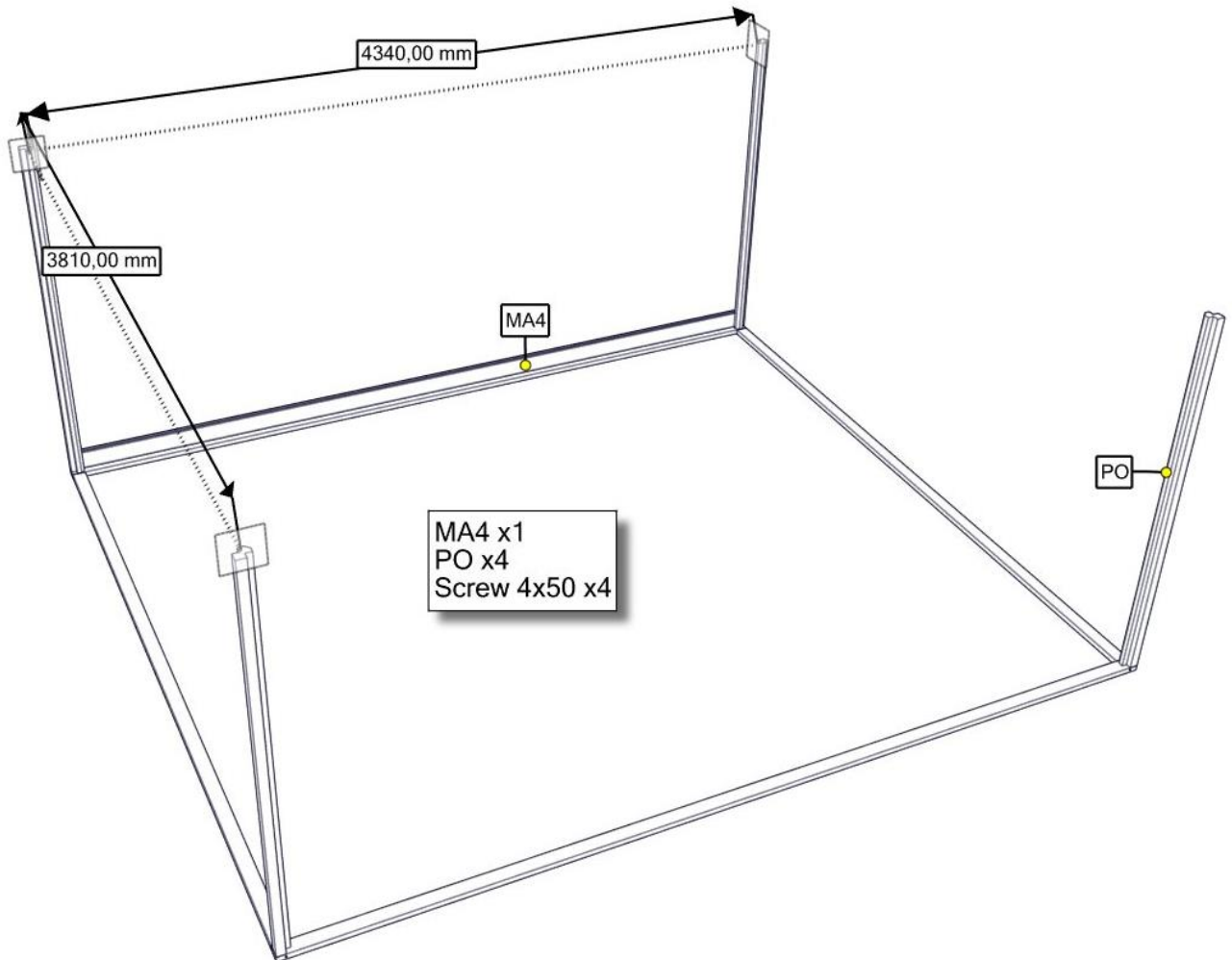

5/61

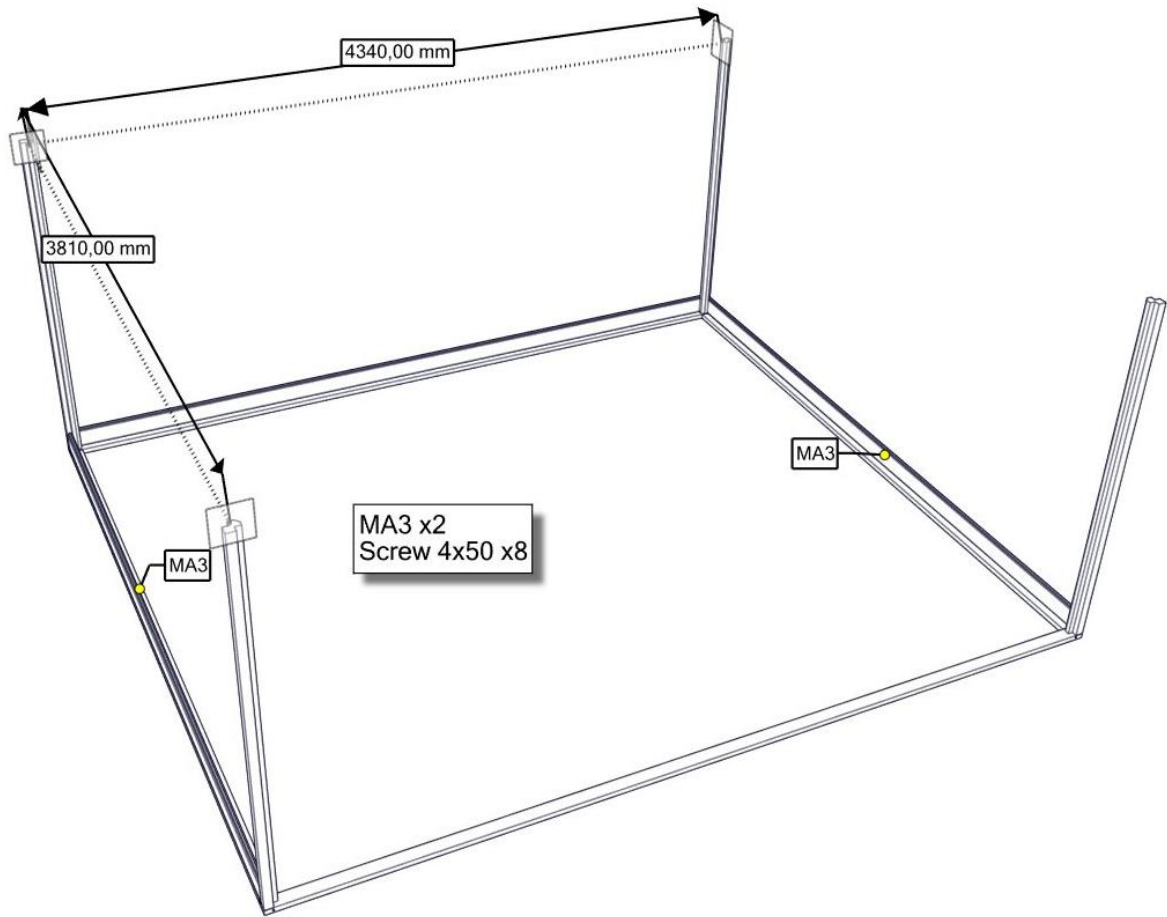

6/61

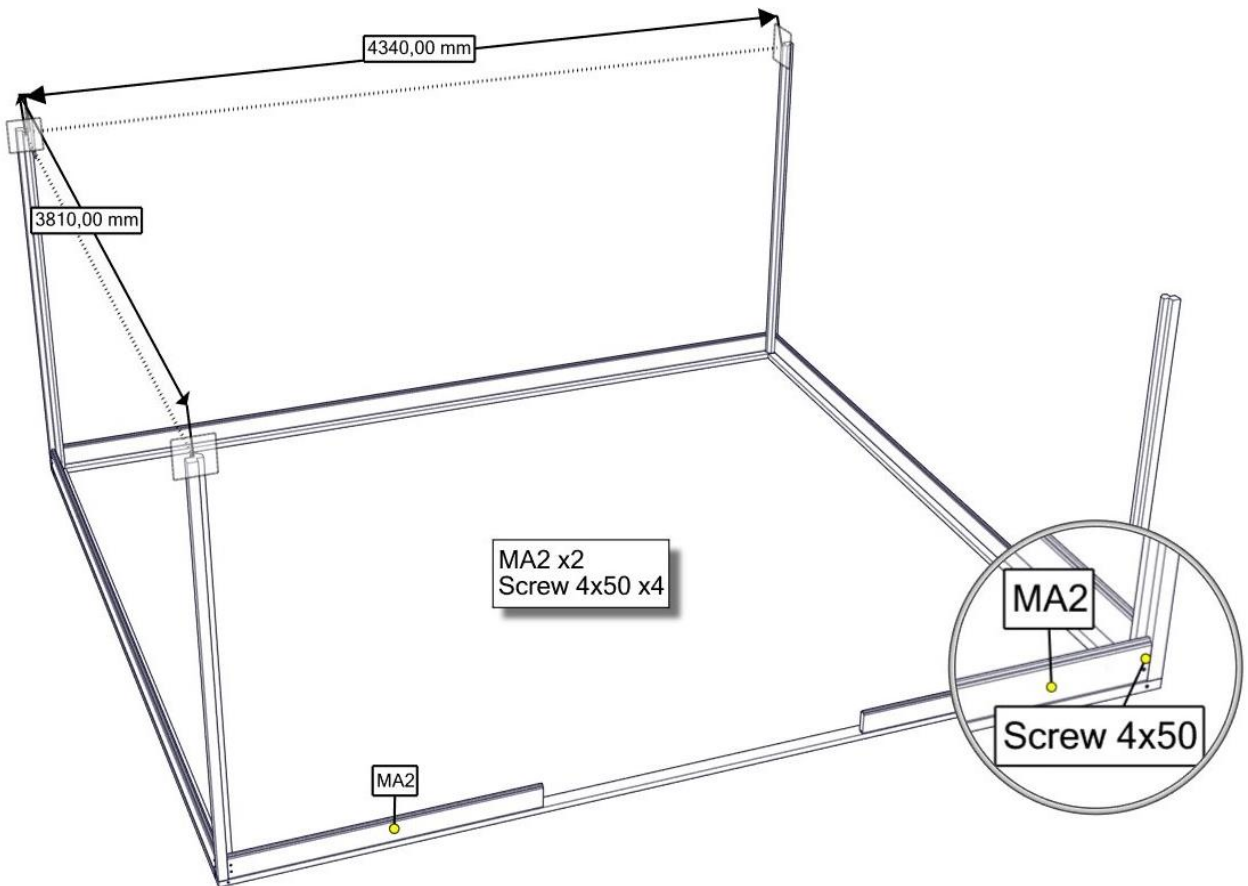

7/61

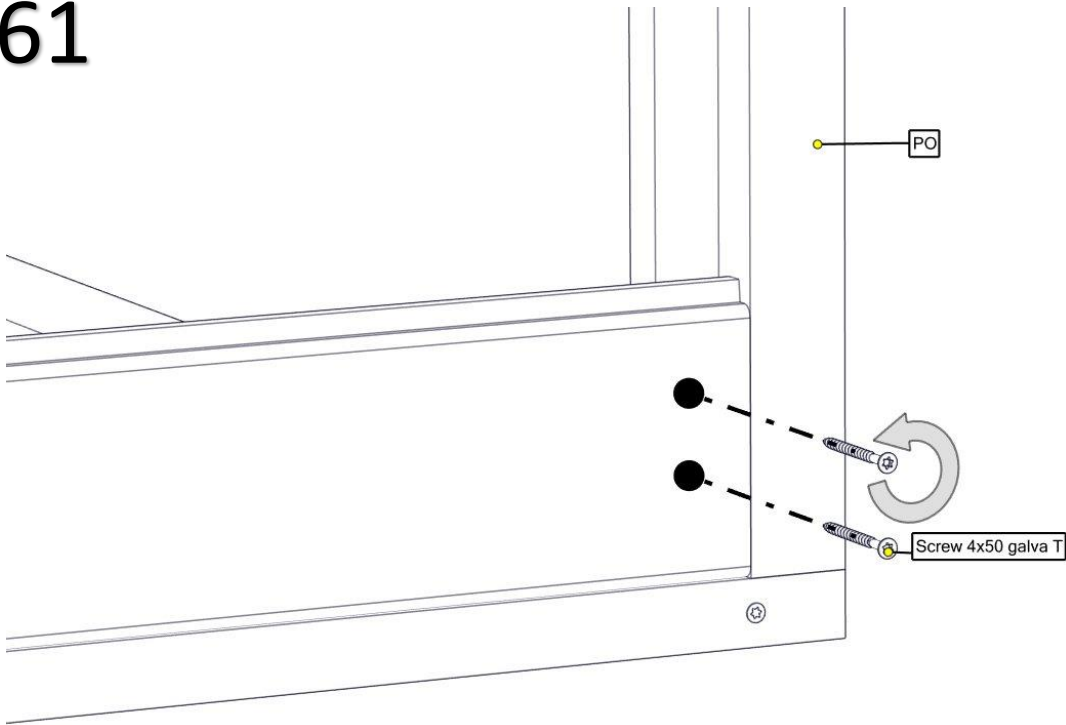

8/61

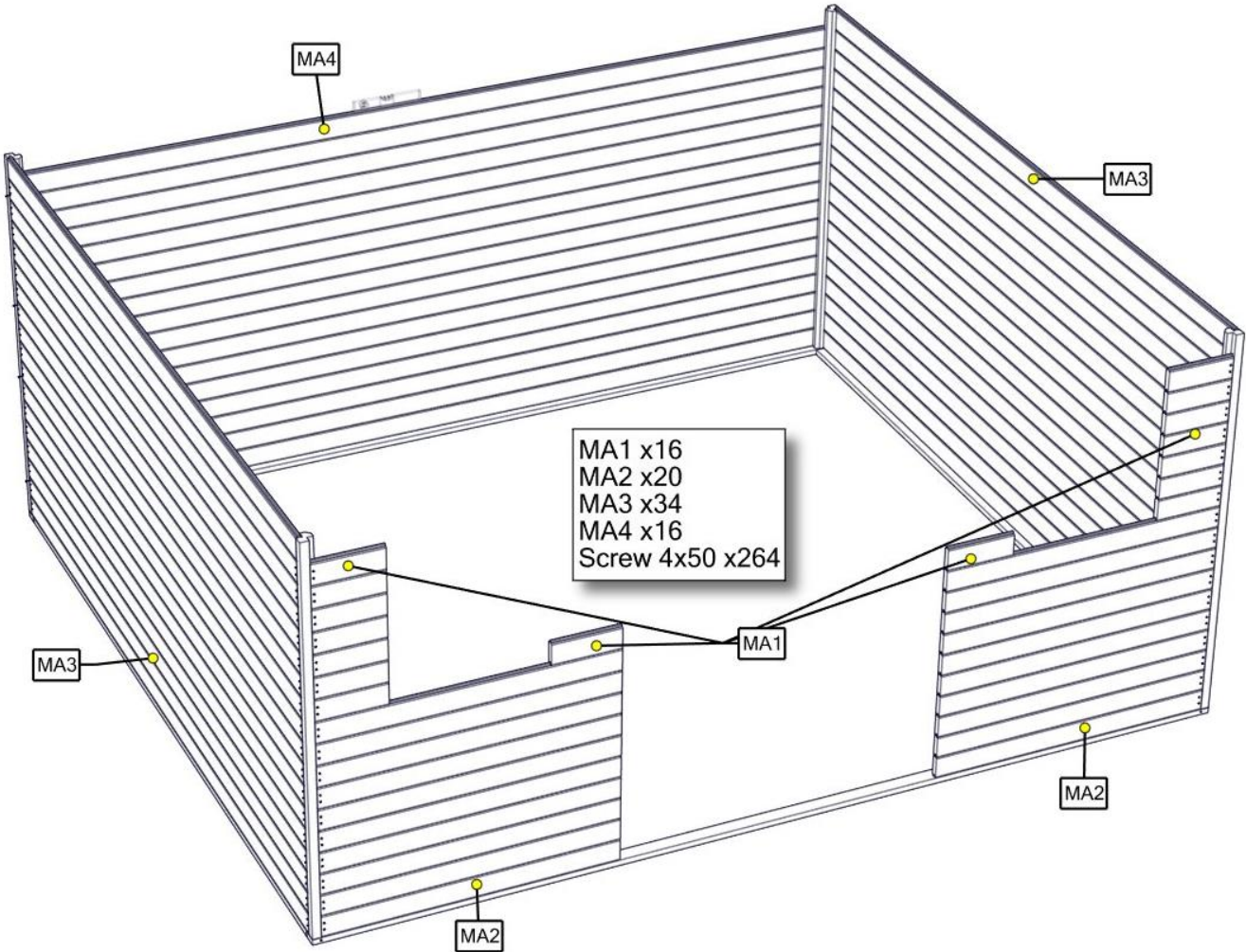

9/61

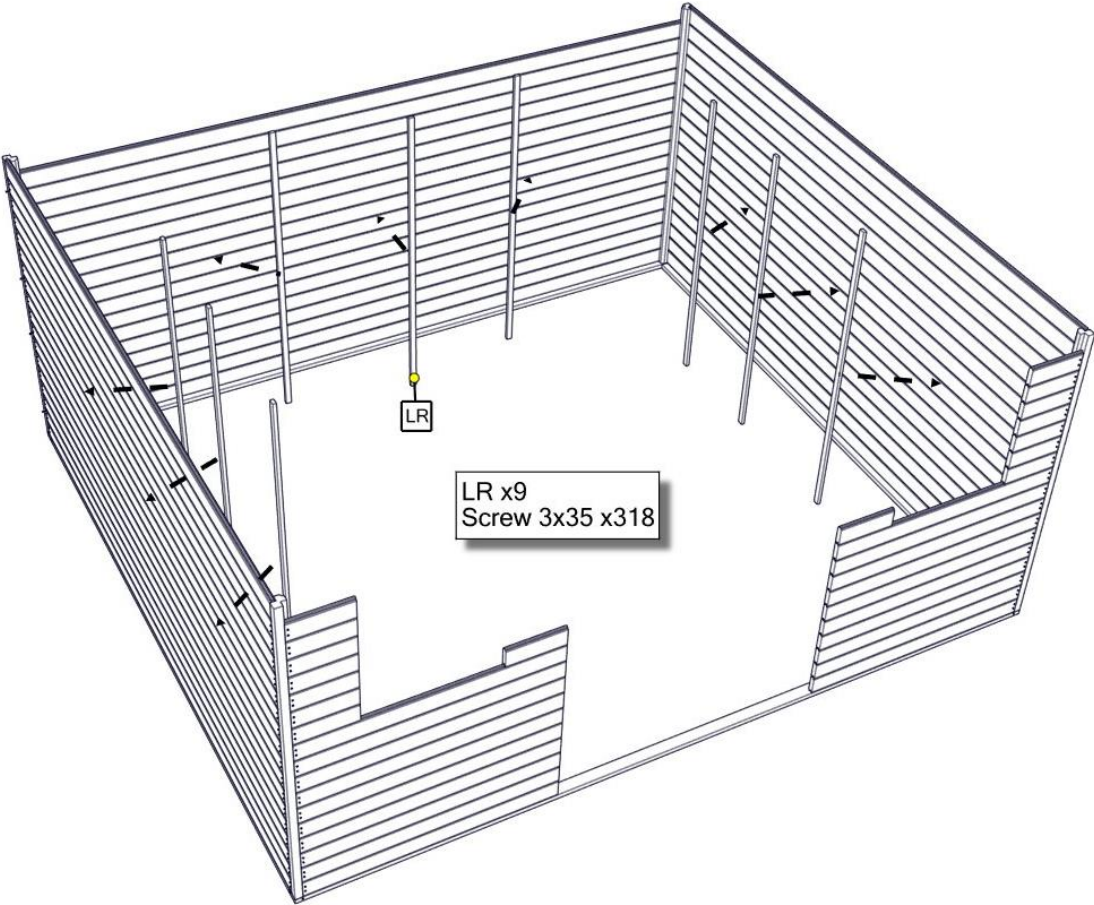

10/61

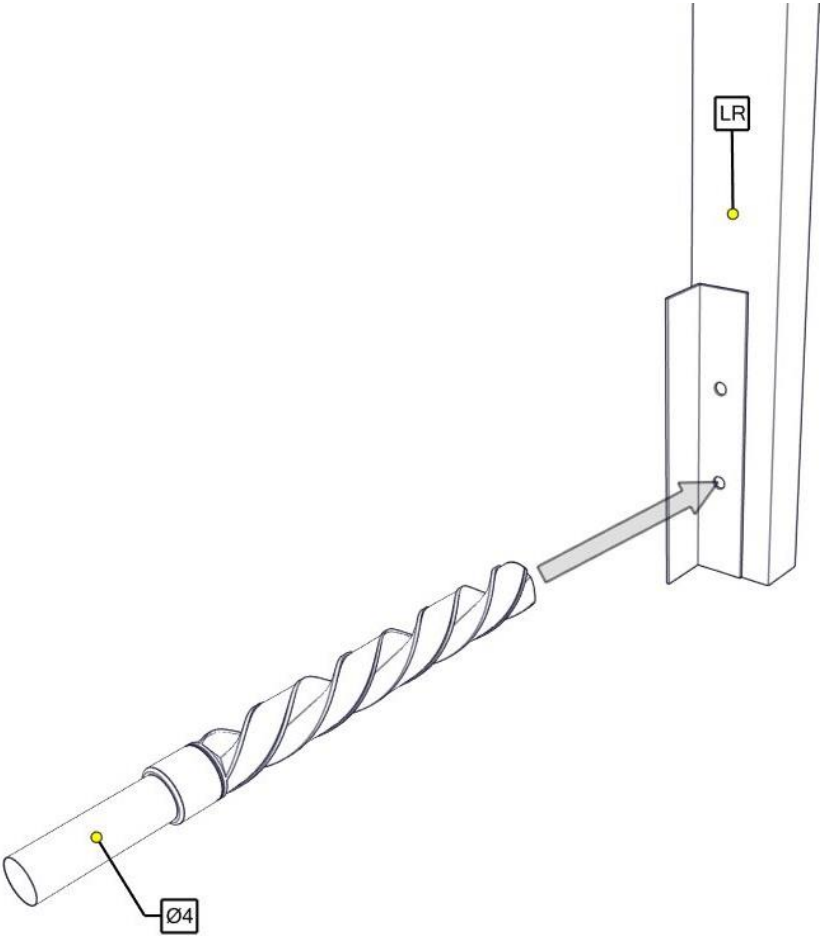

11/61

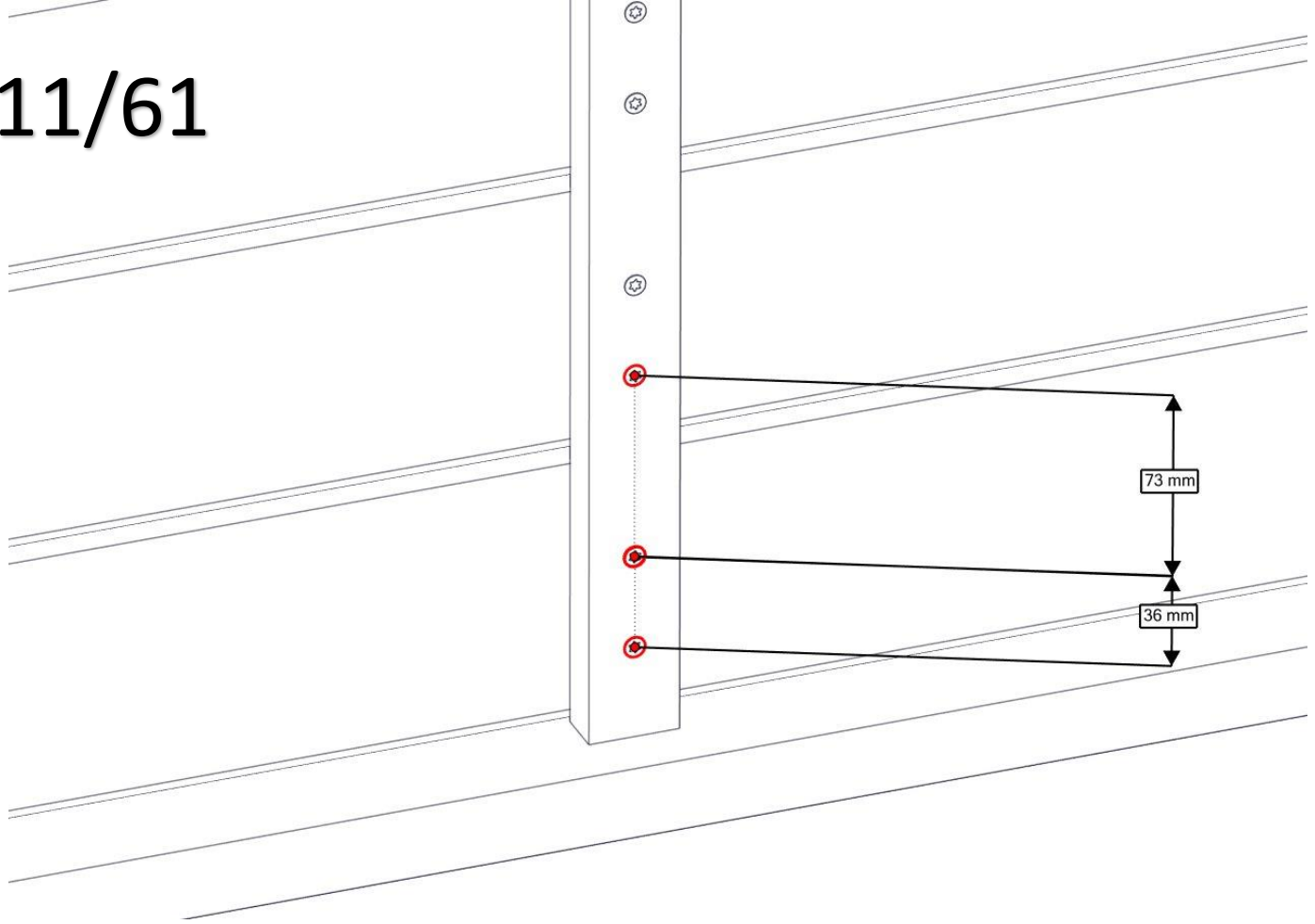

12/61

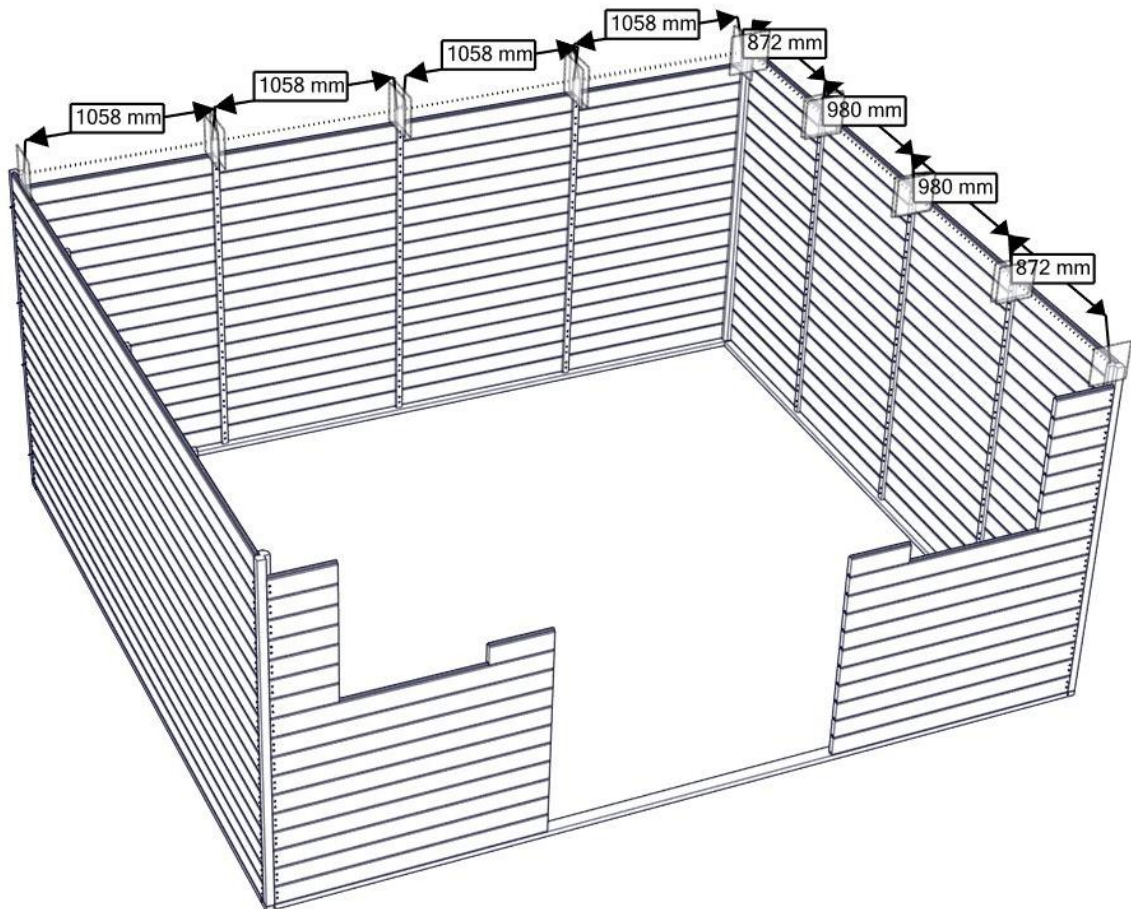

13/61

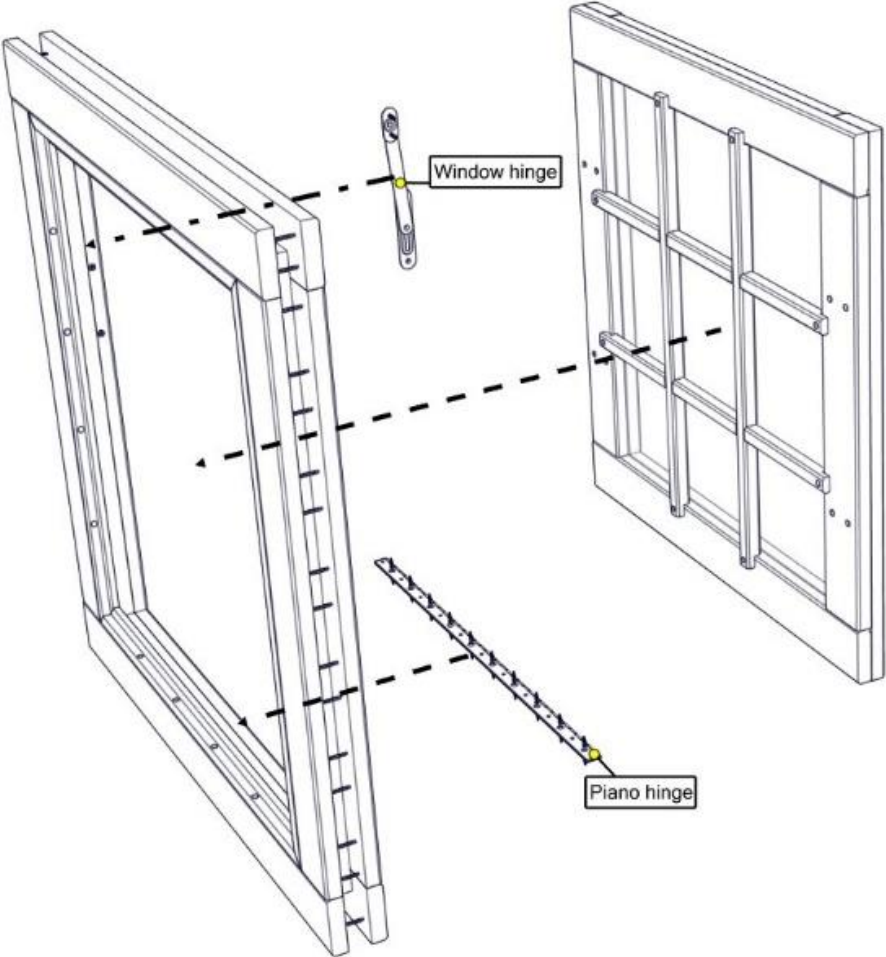

14/61

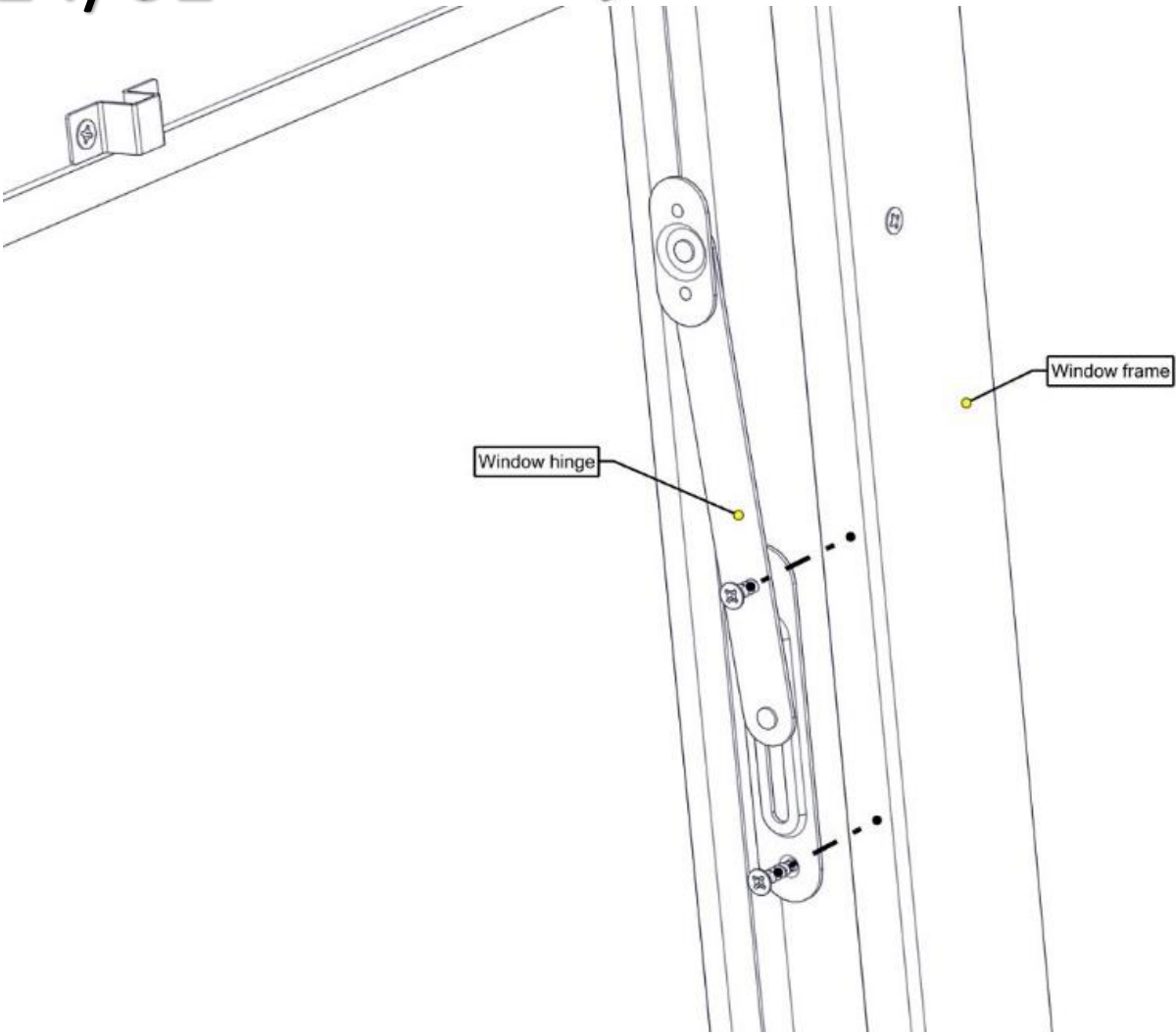

15/61

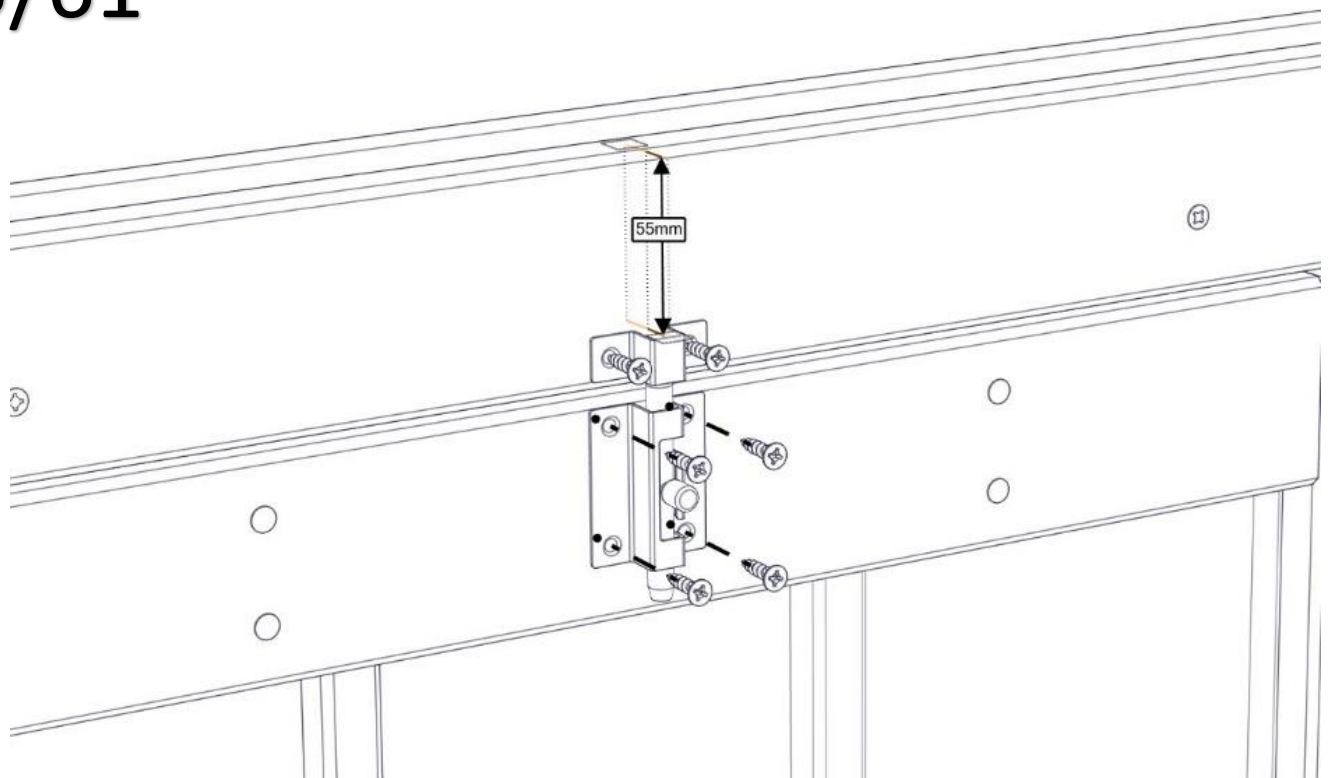

16/61

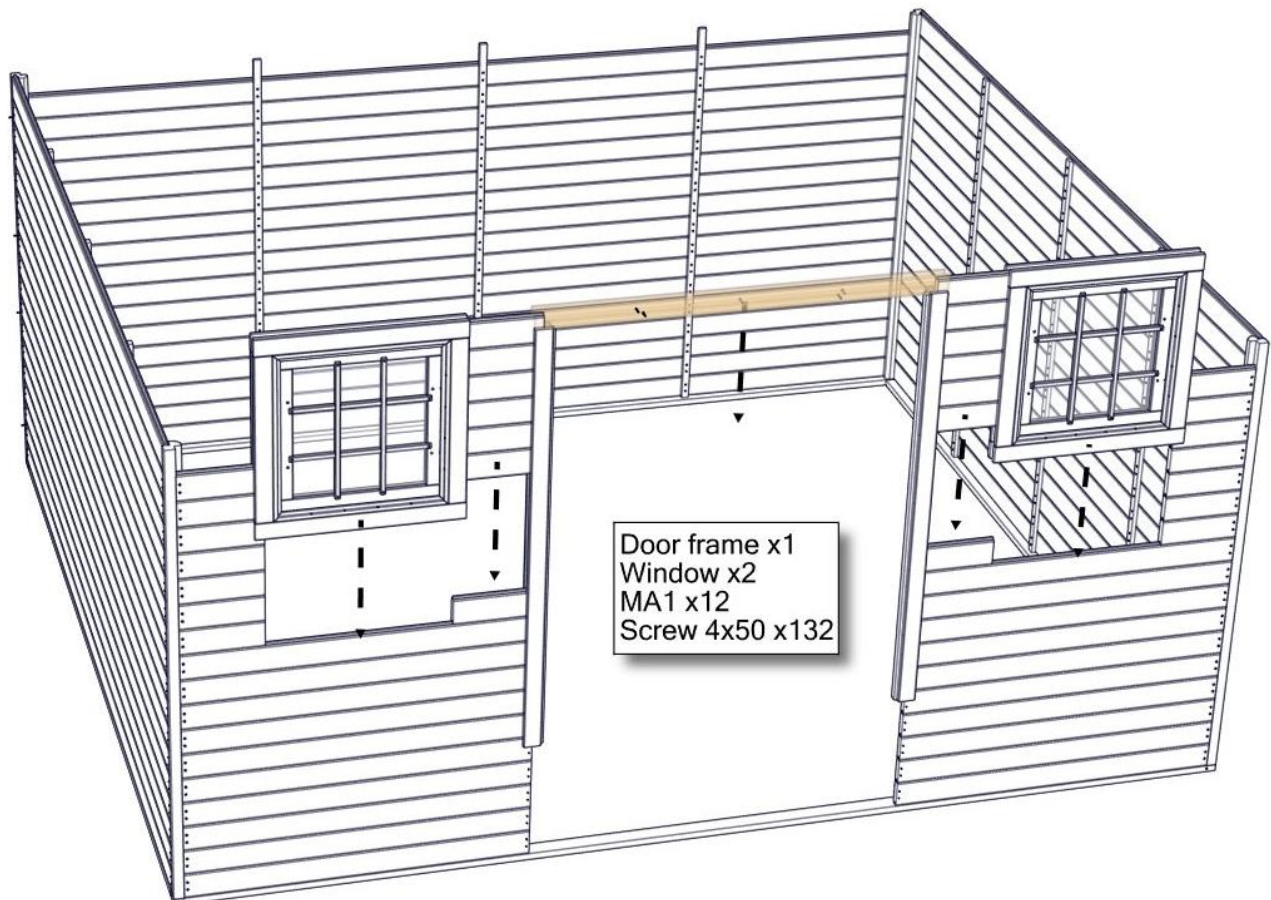

17/61

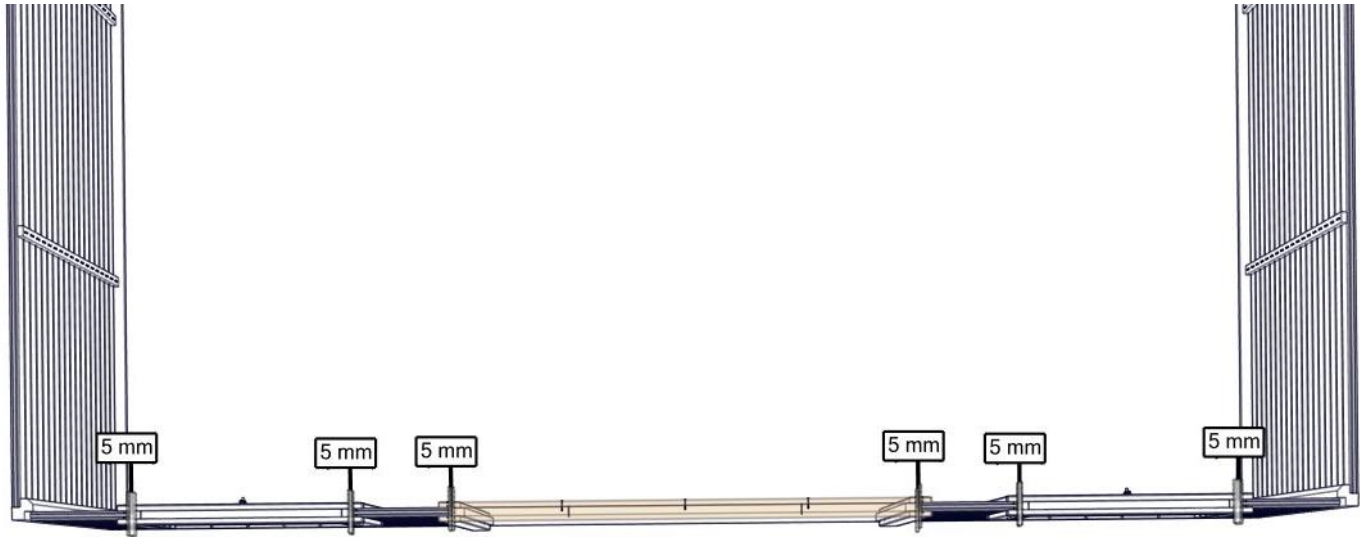

18/61

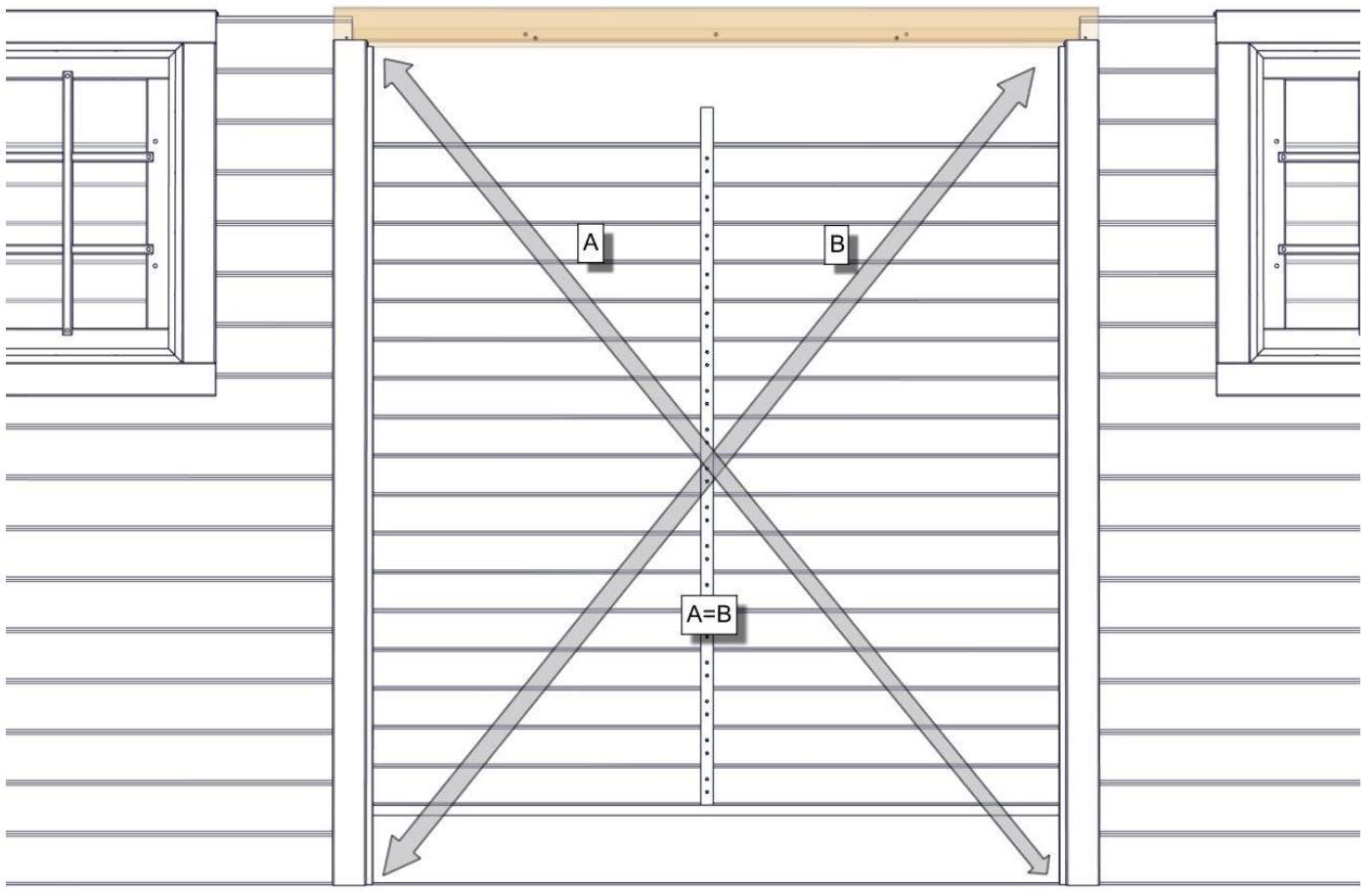

19/61

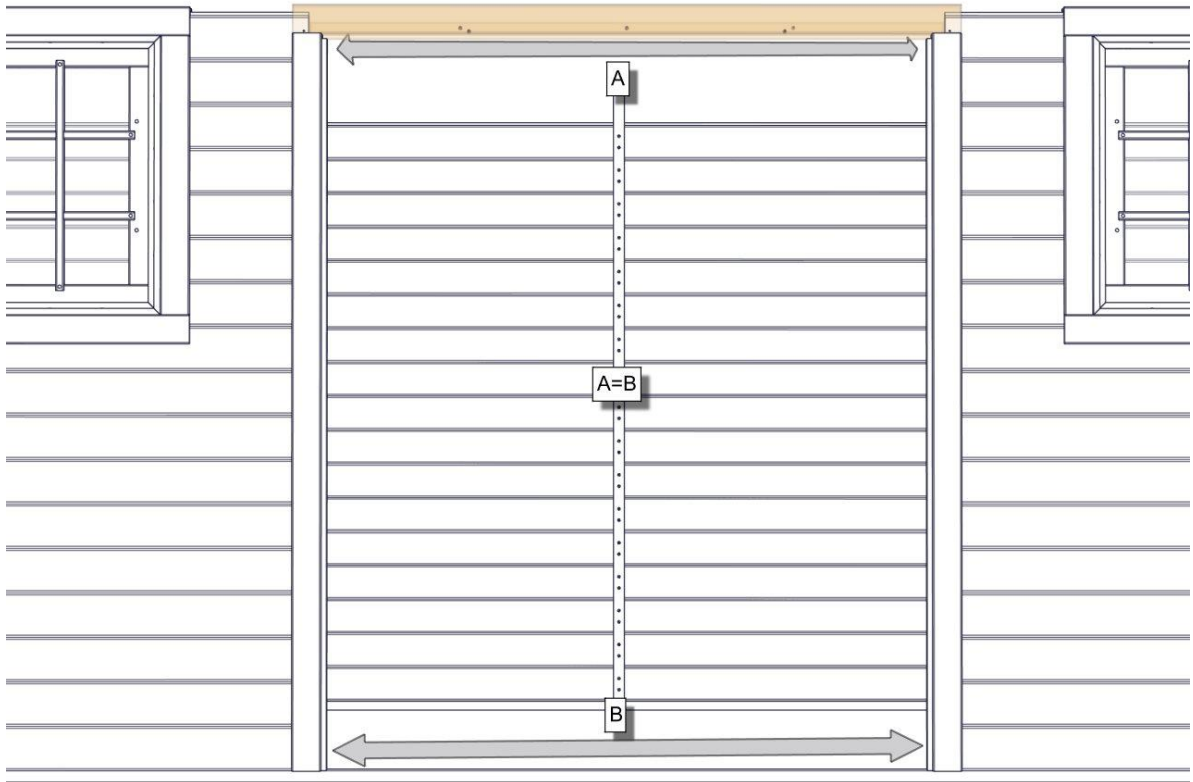

20/61

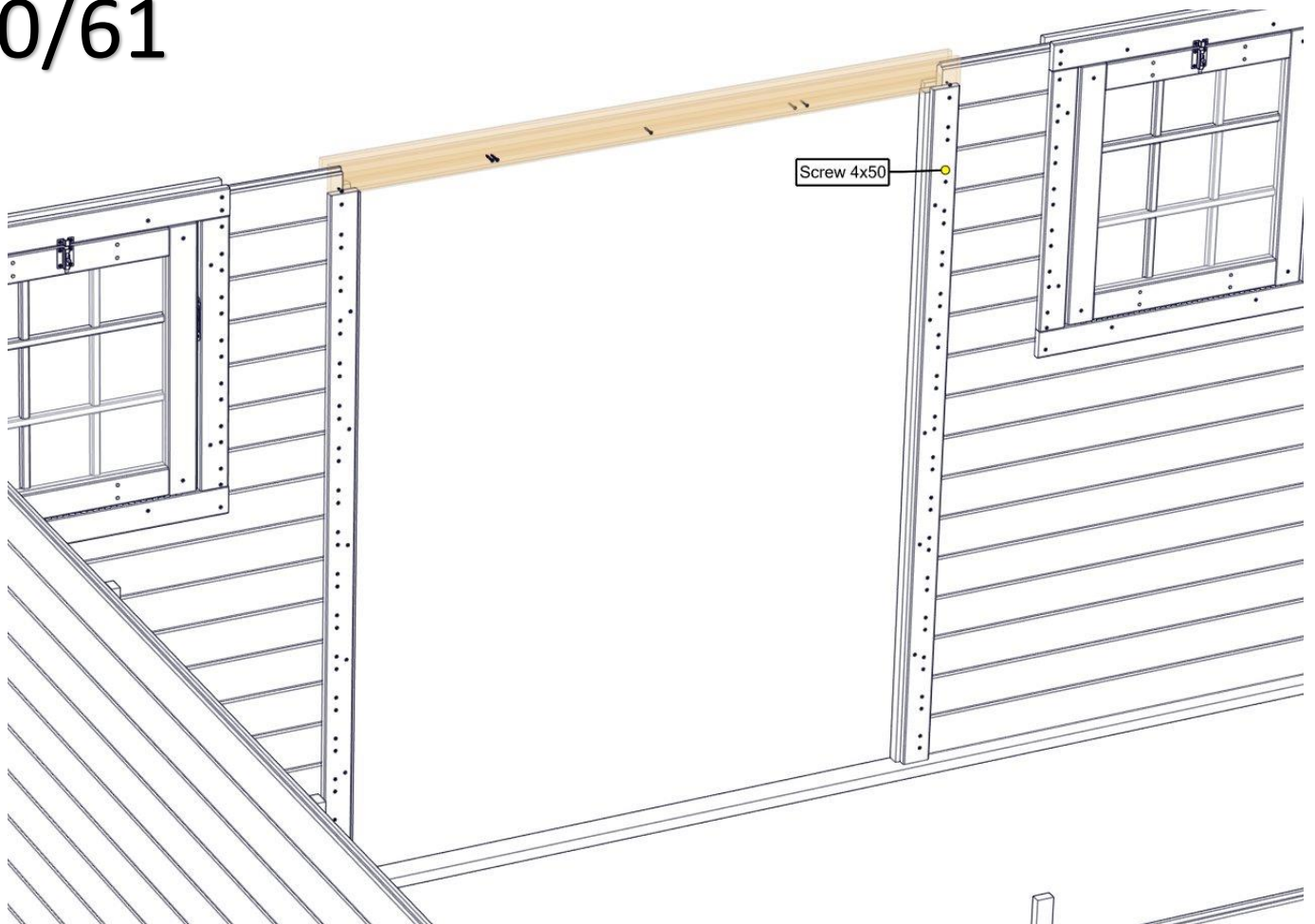

21/61



22/61

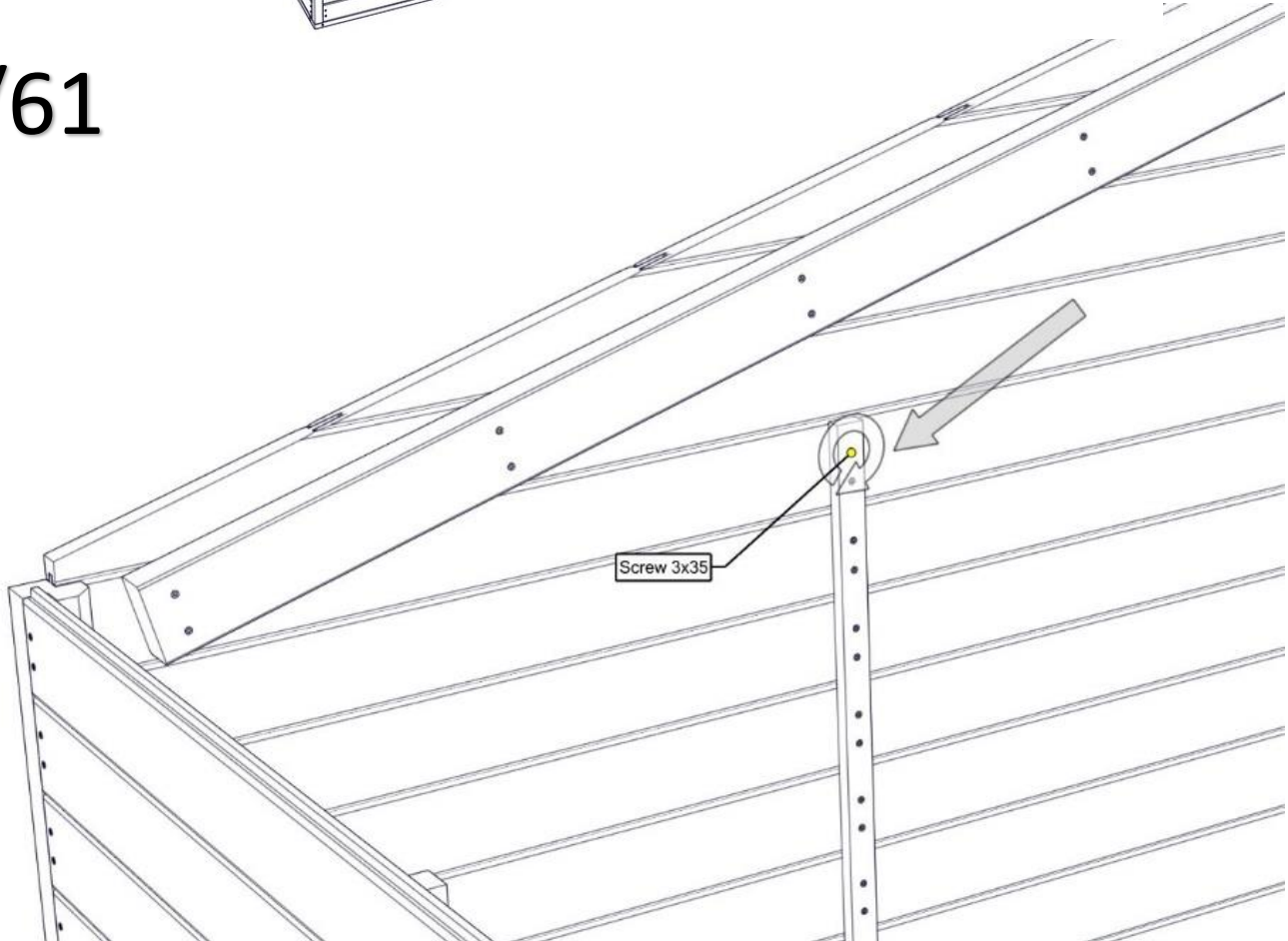

23/61

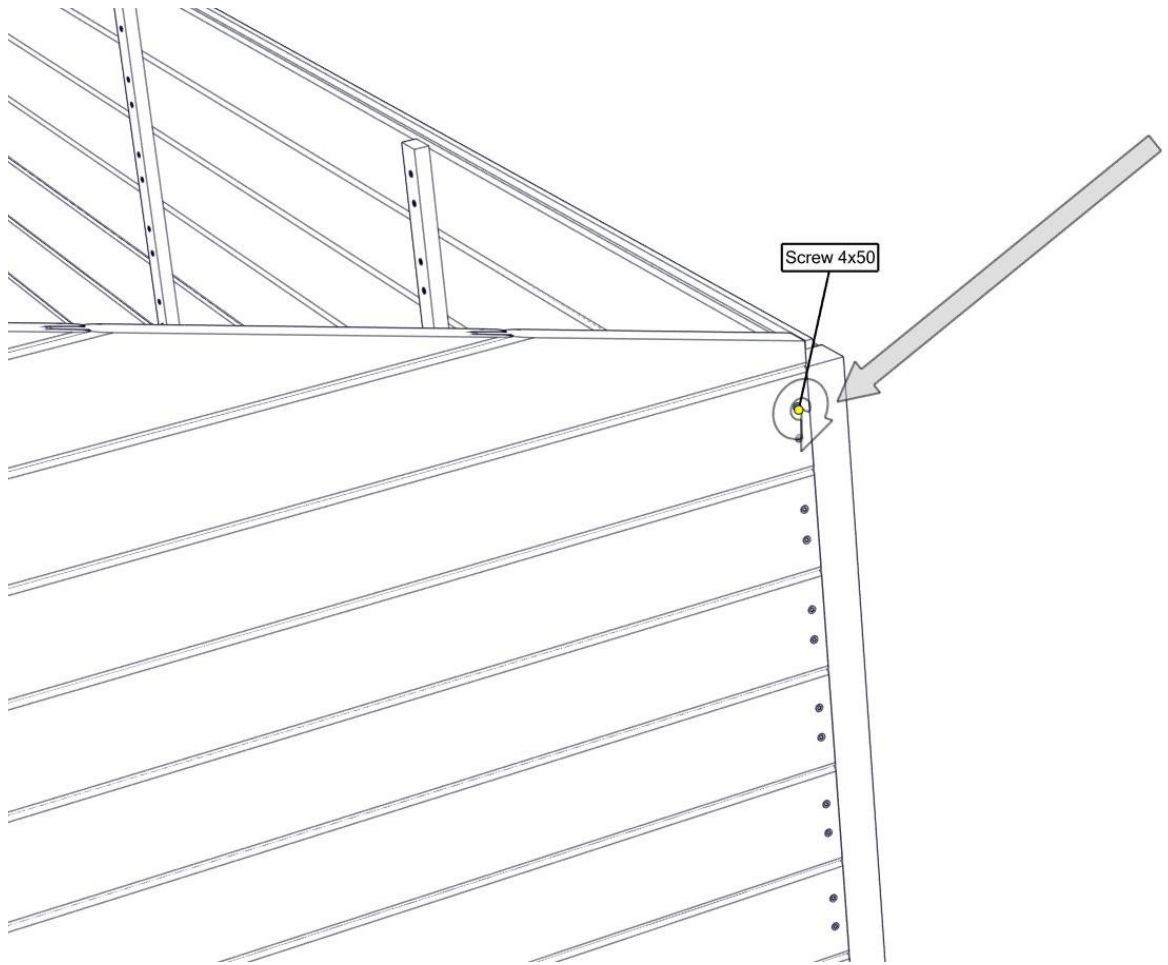

24/61

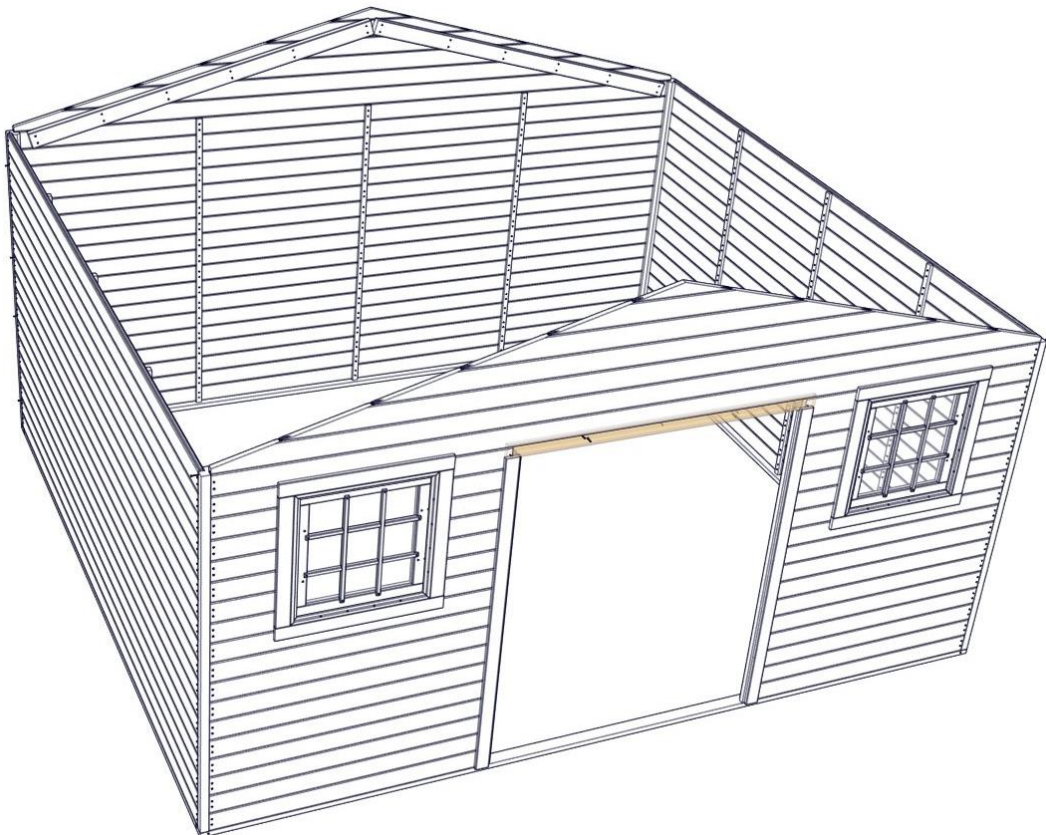

25/61

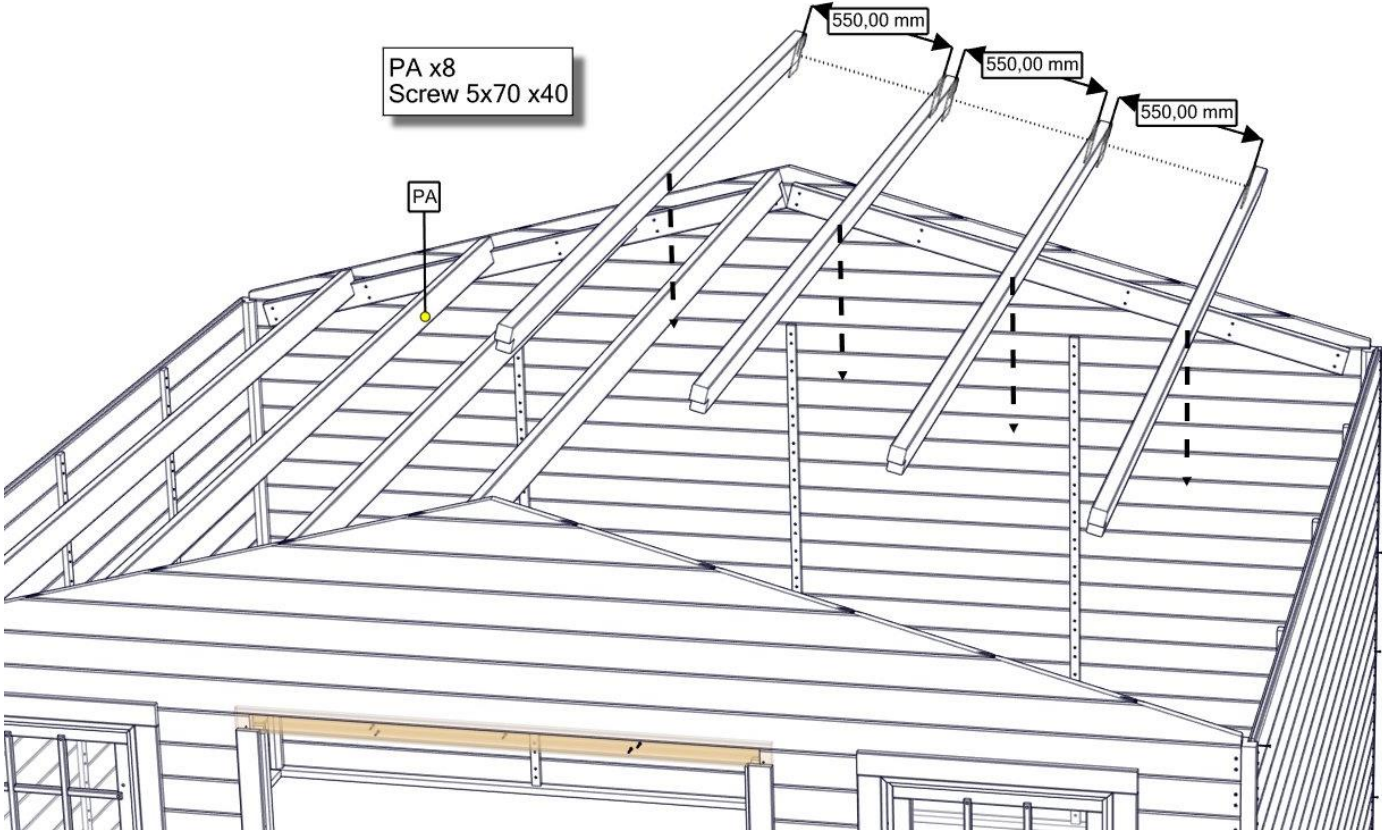

26/61

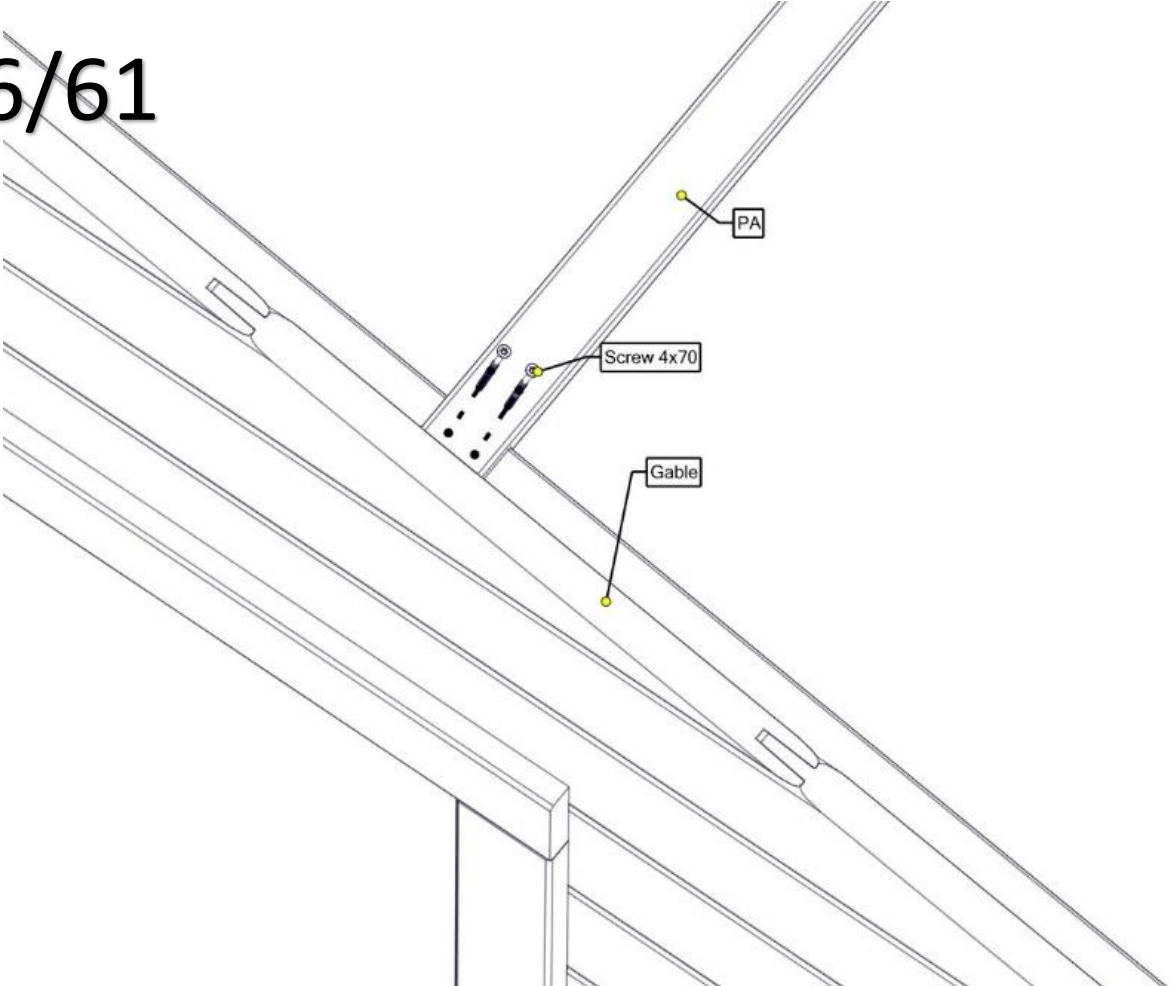

27/61

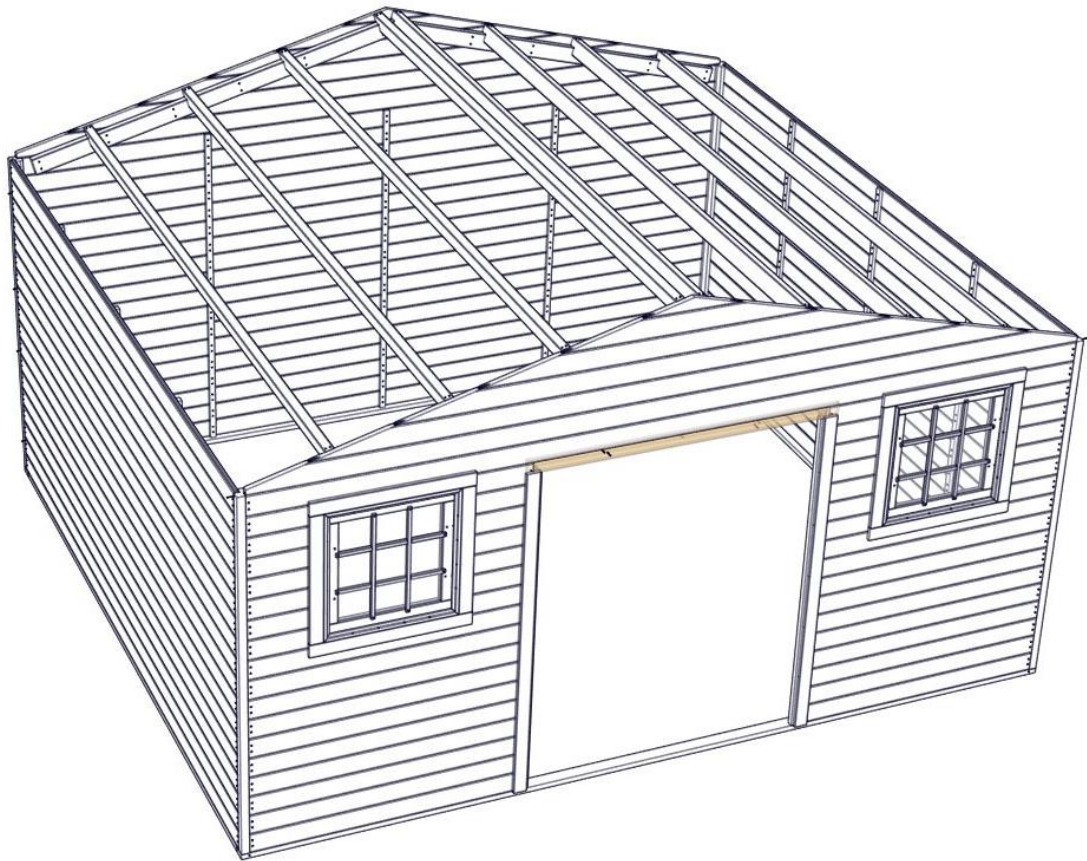

28/61

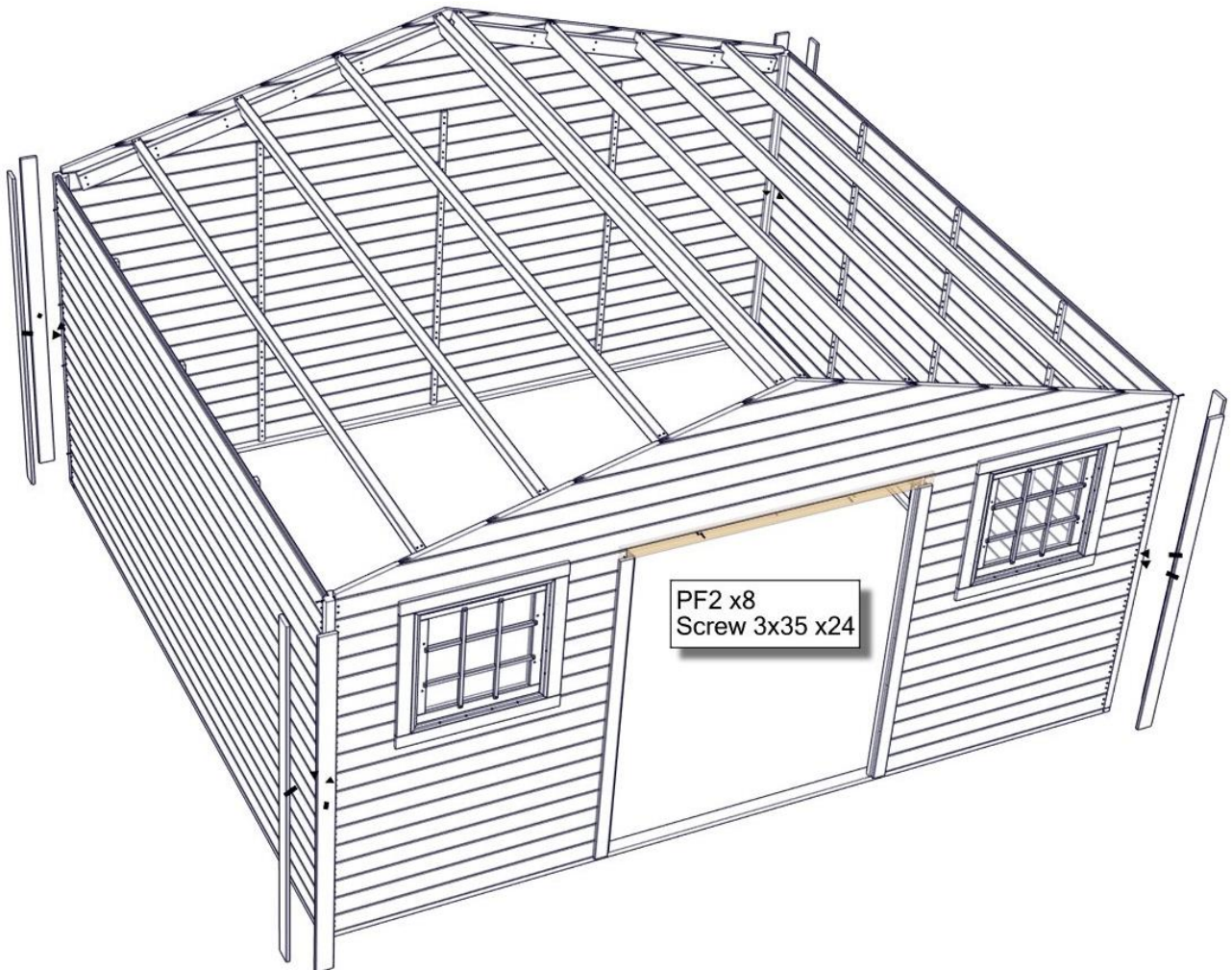

29/61

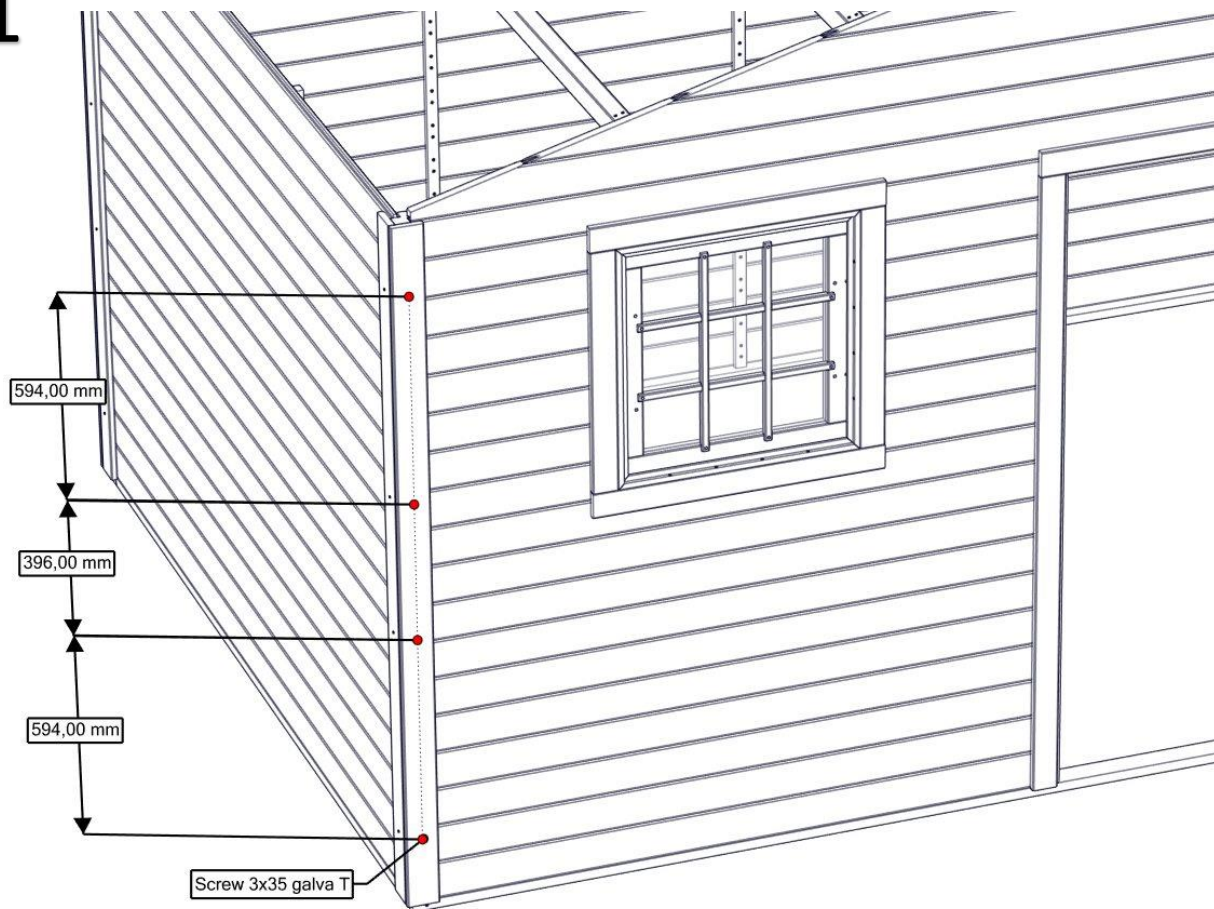

30/61

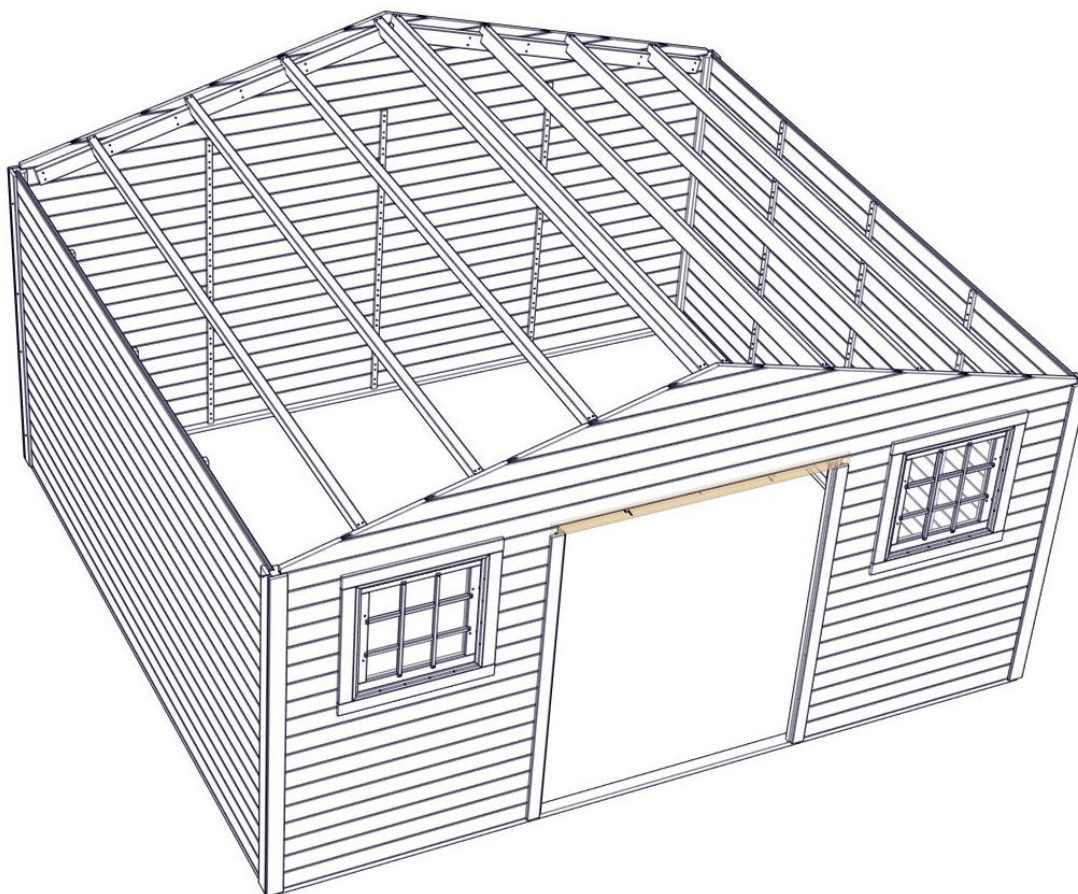

31/61

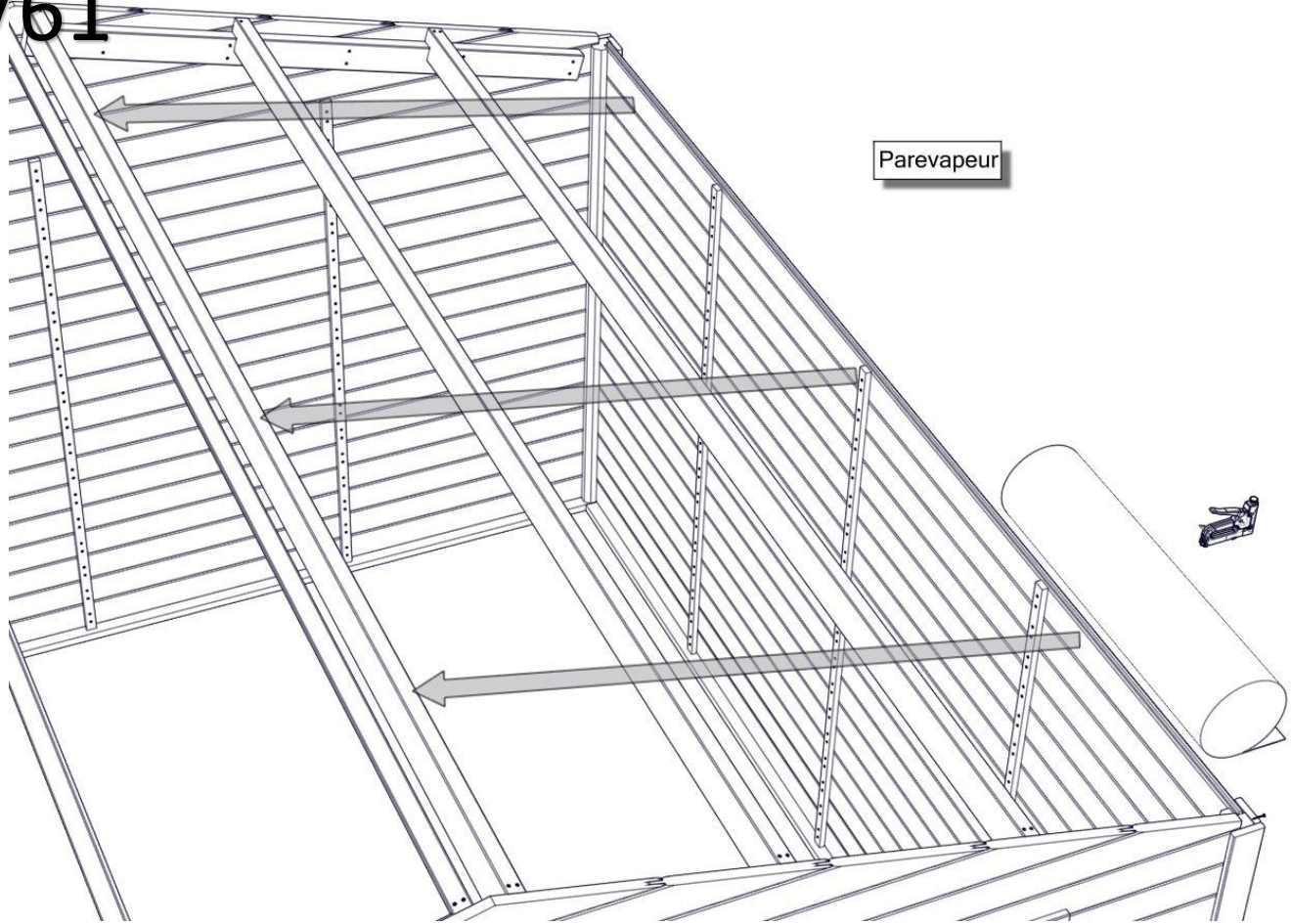

32/61

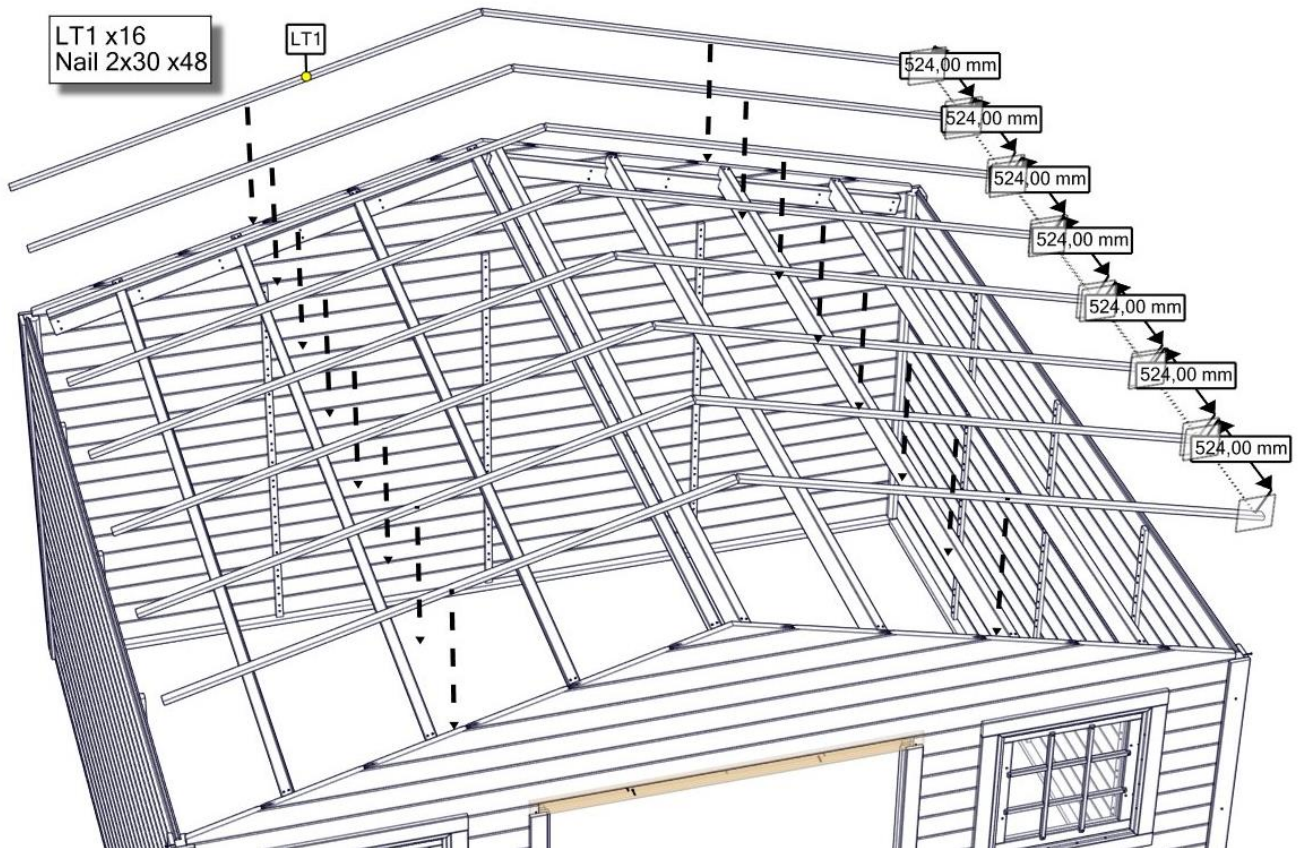

33/61

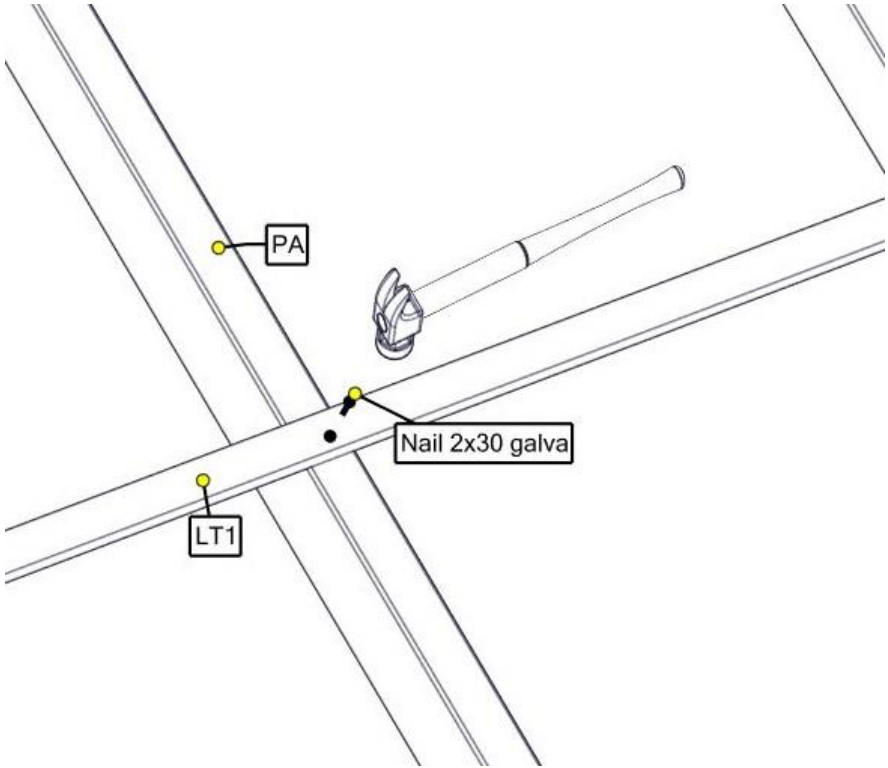

34/61

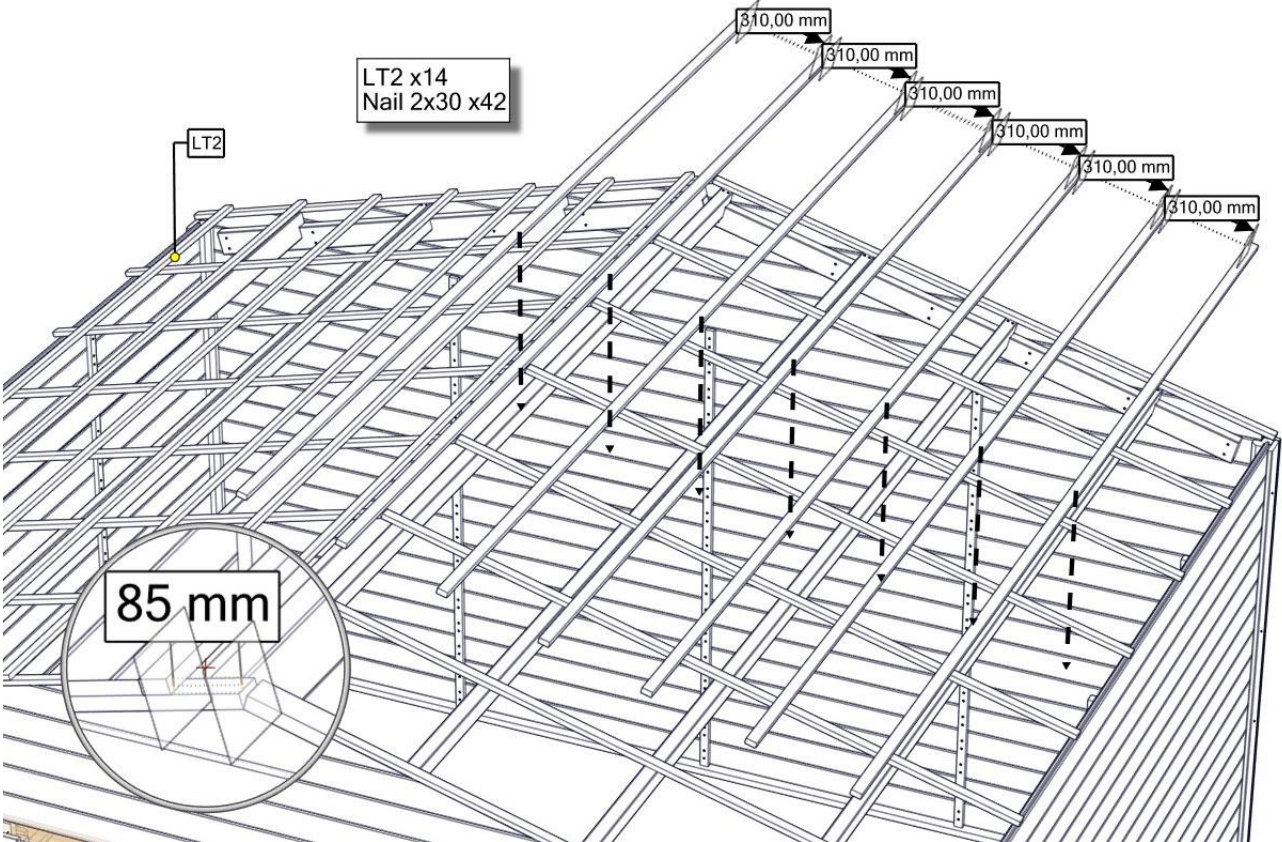

35/61

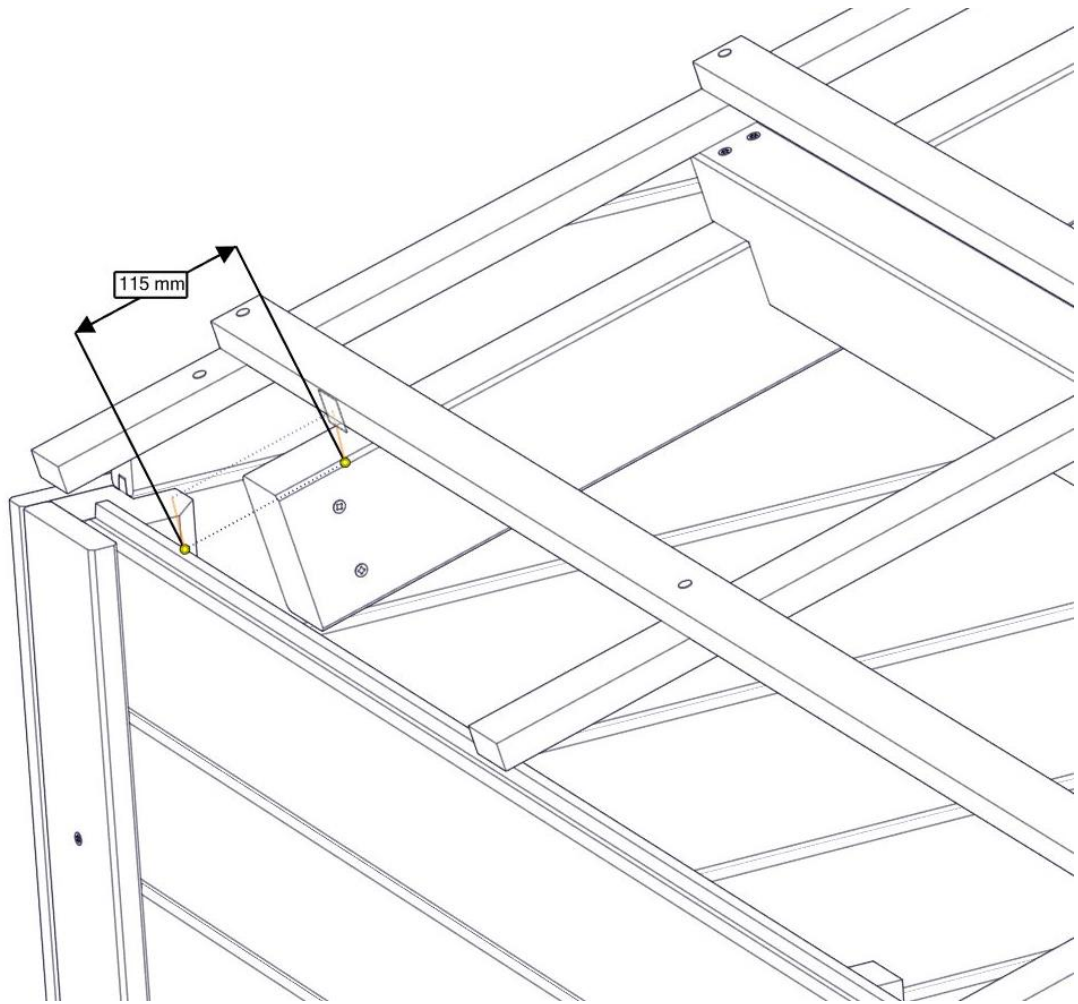

36/61

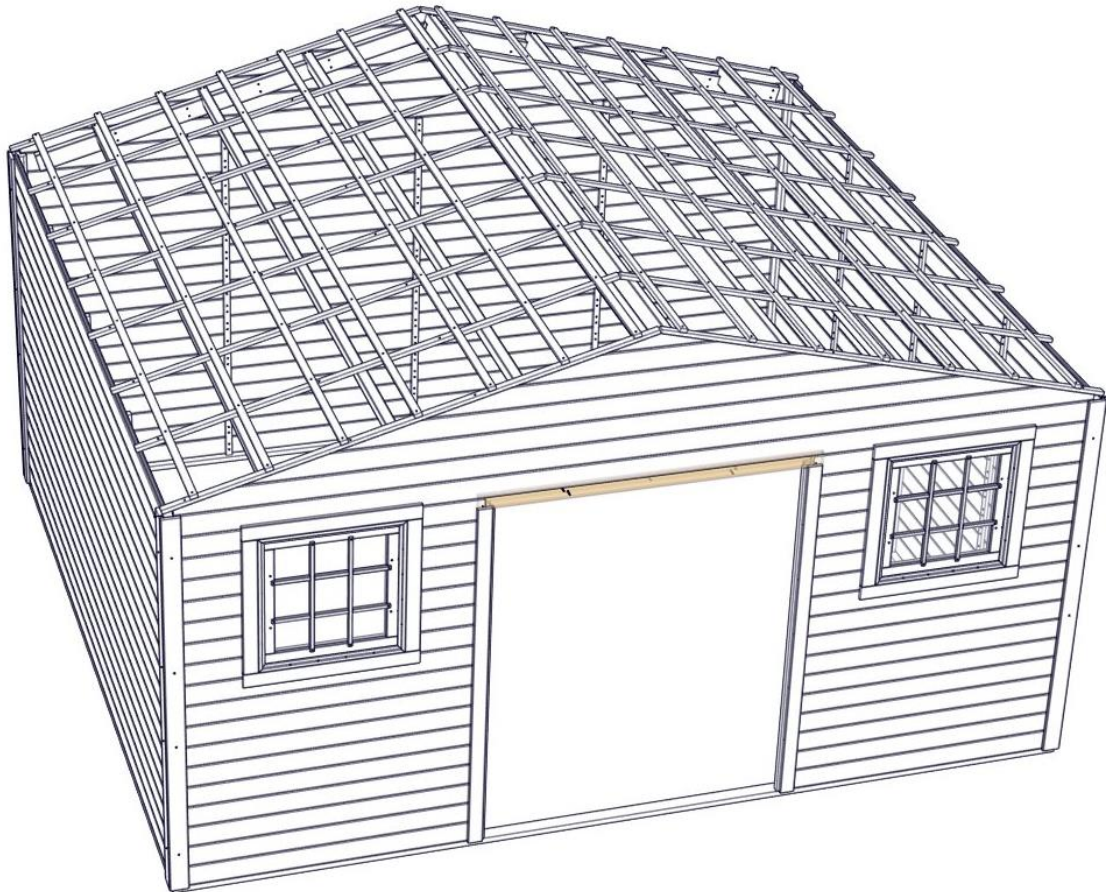

37/61

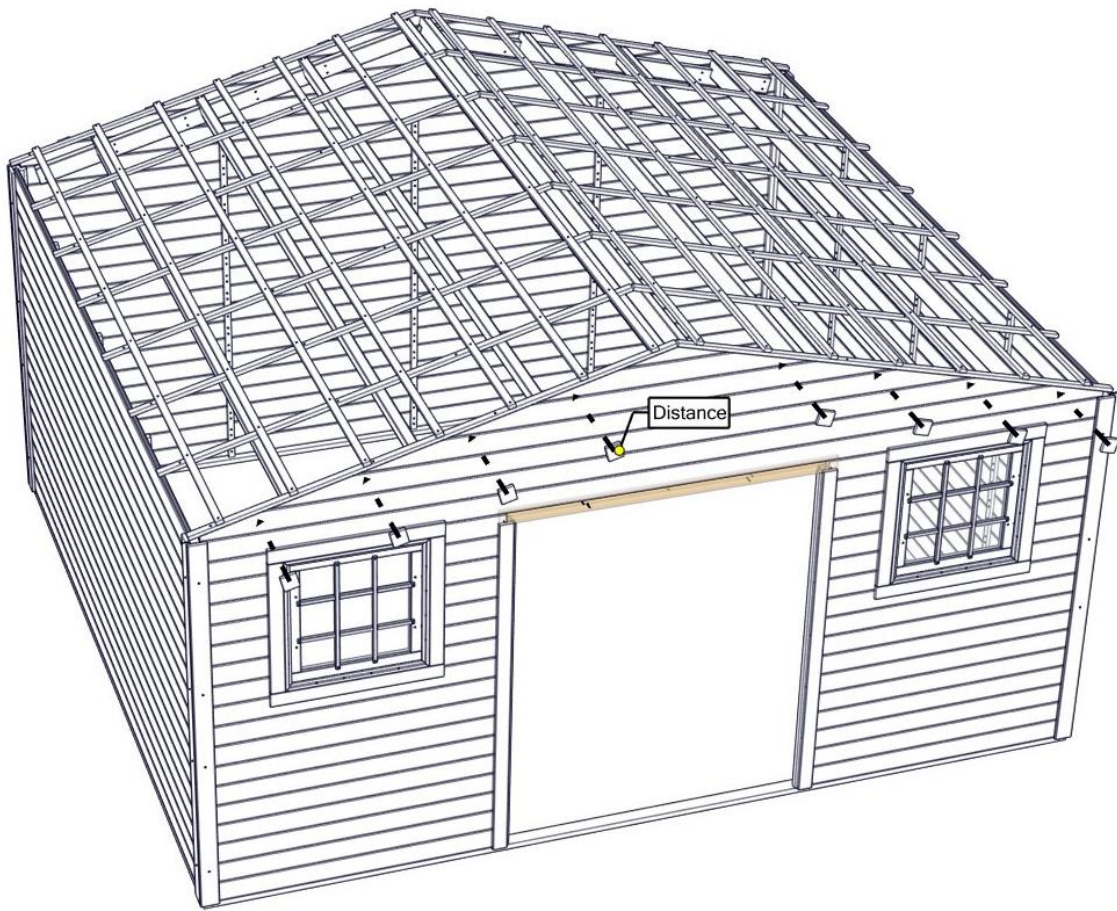

38/61

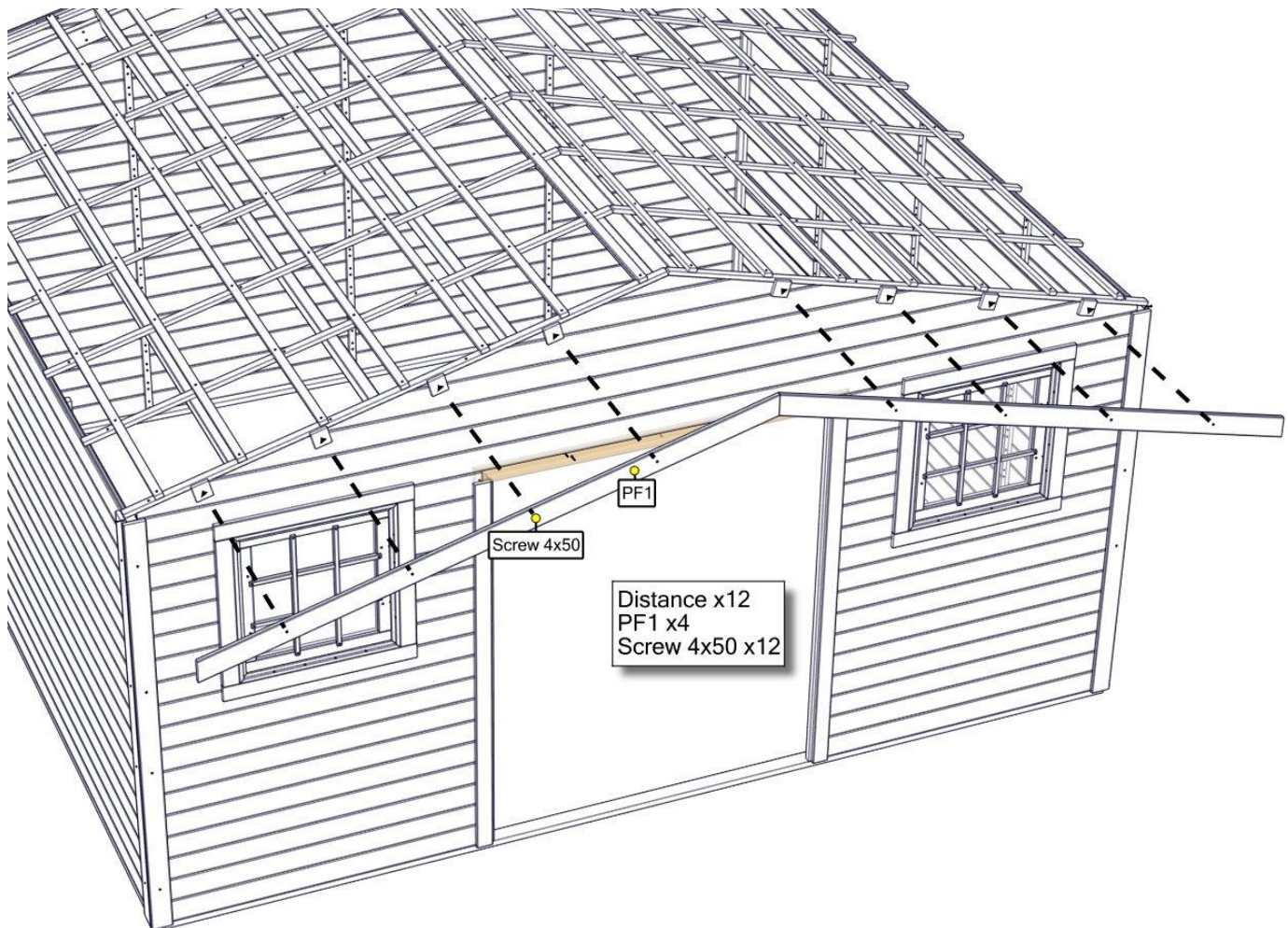

39/61

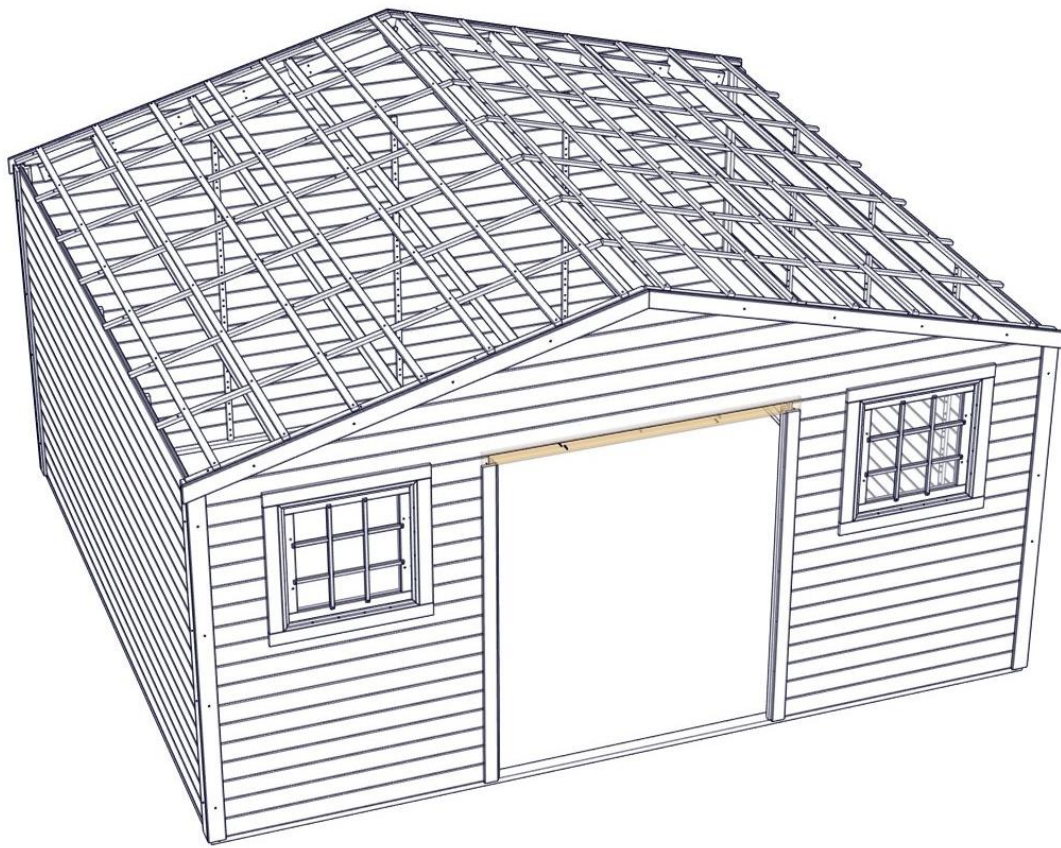

40/61

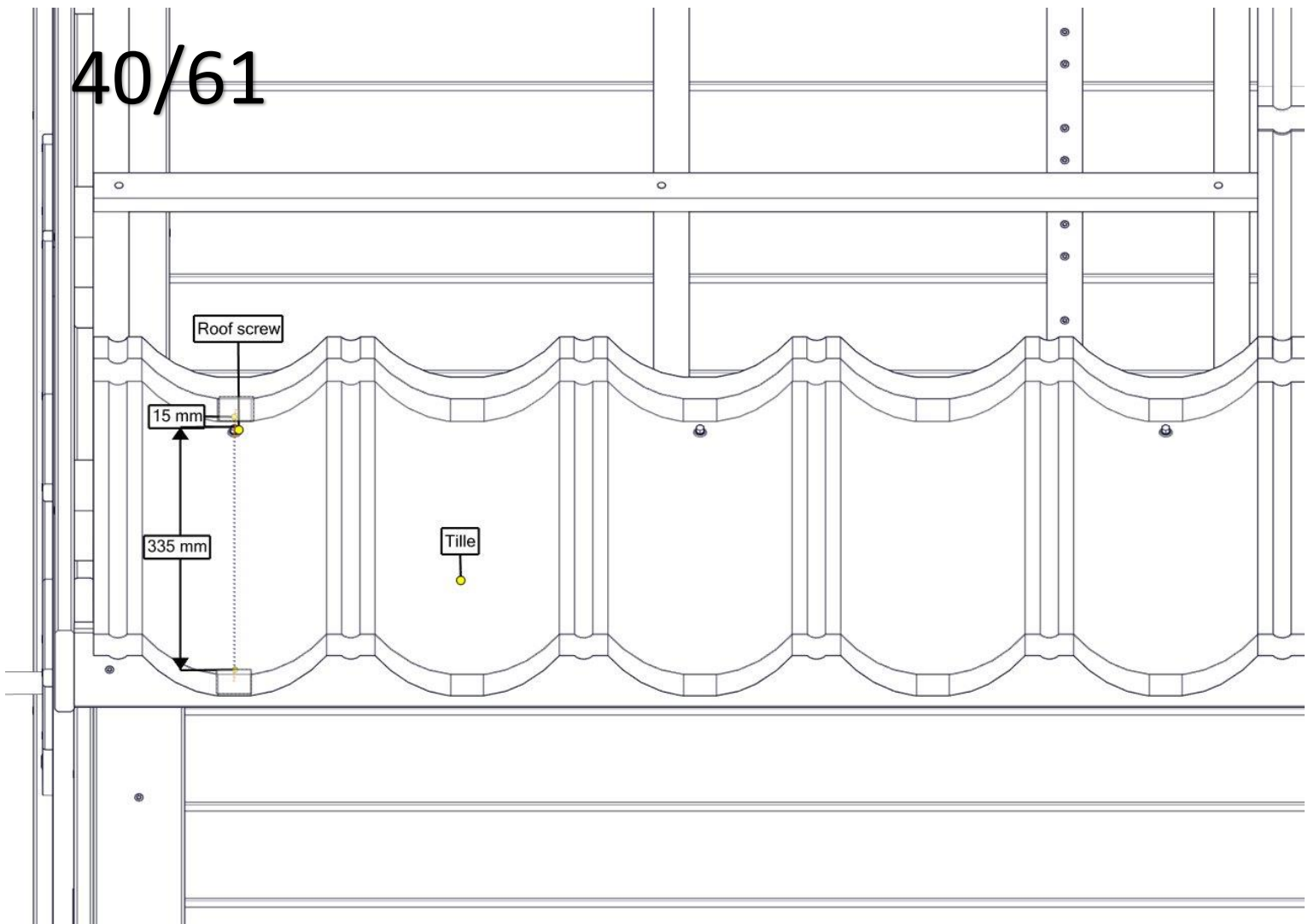

41/61

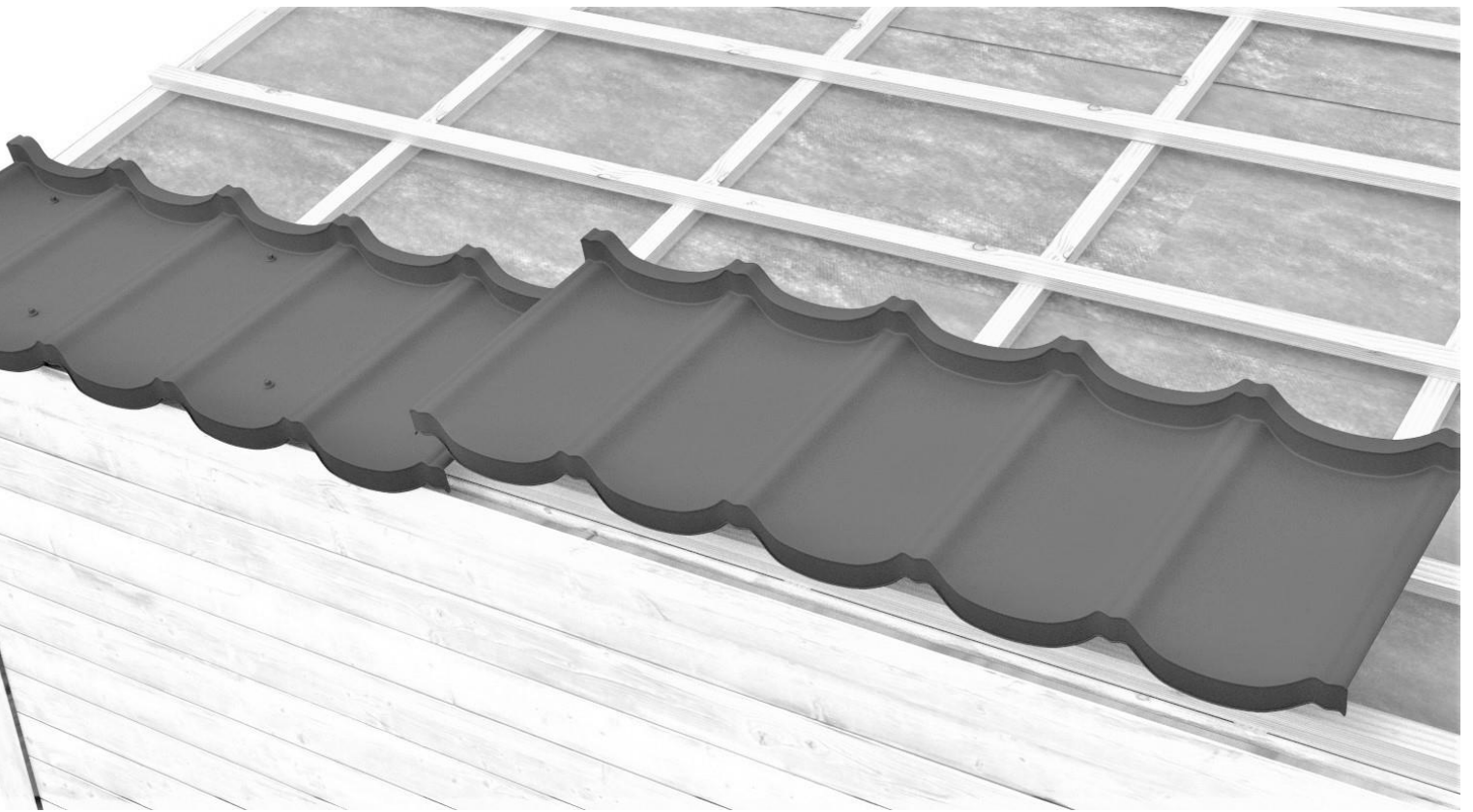

42/61



43/61



44/61

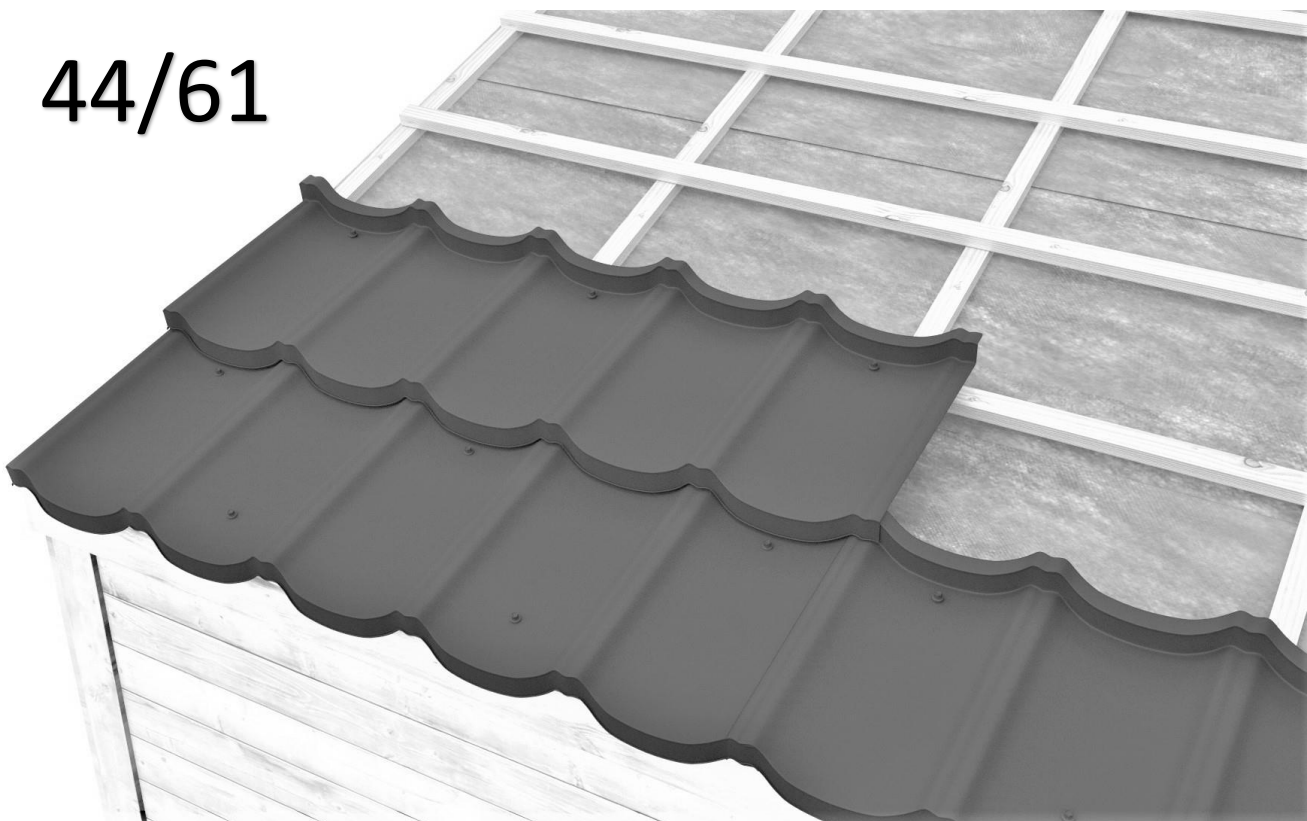

45/61

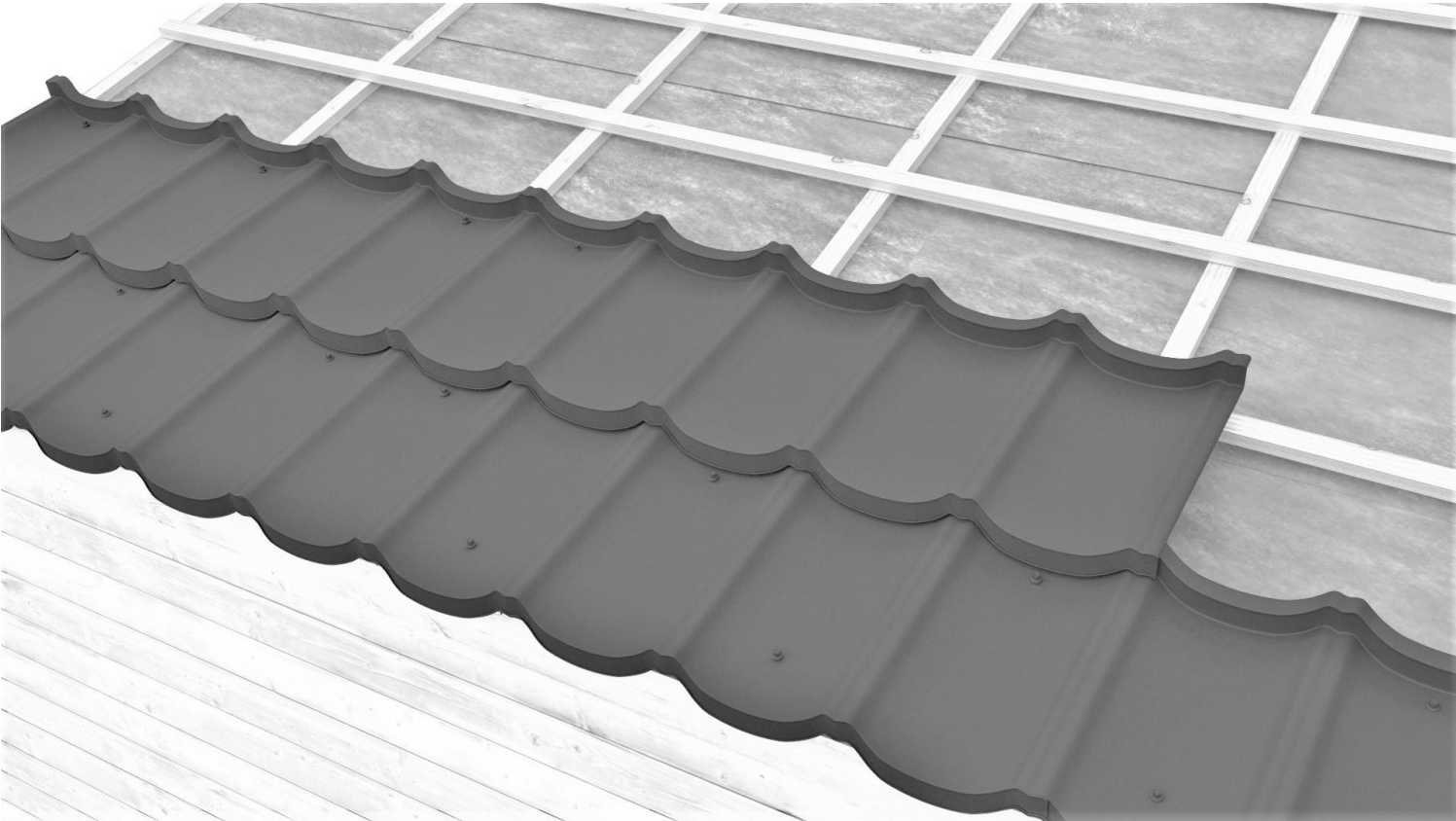

46/61



47/61



48/61

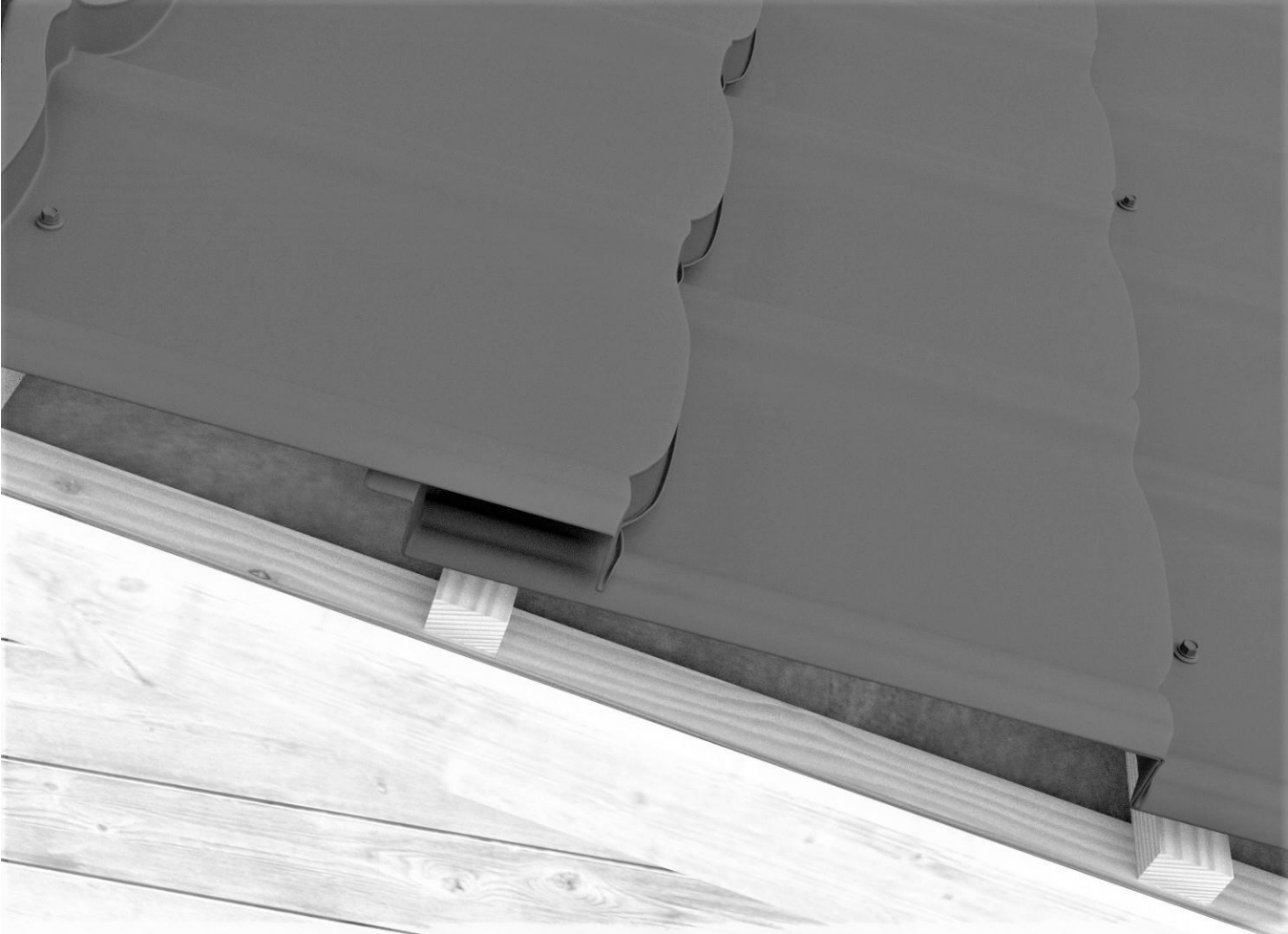

49/61

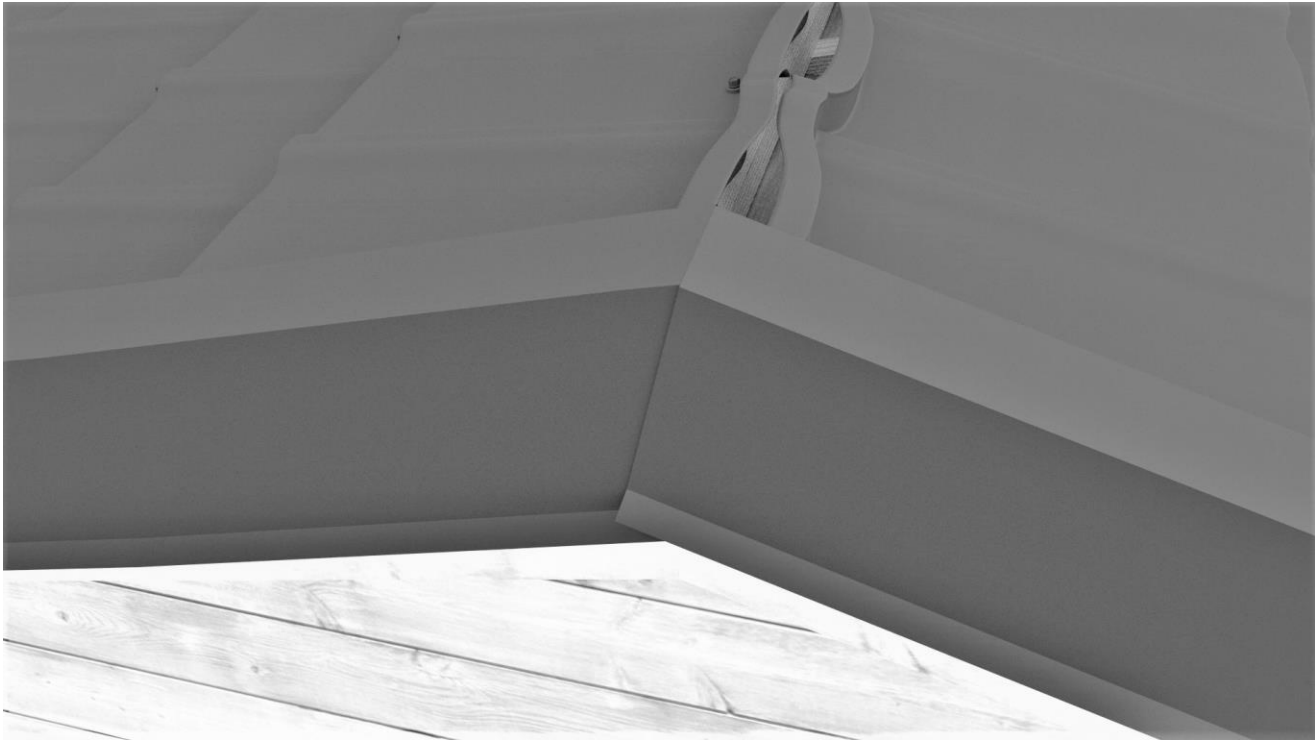

50/61

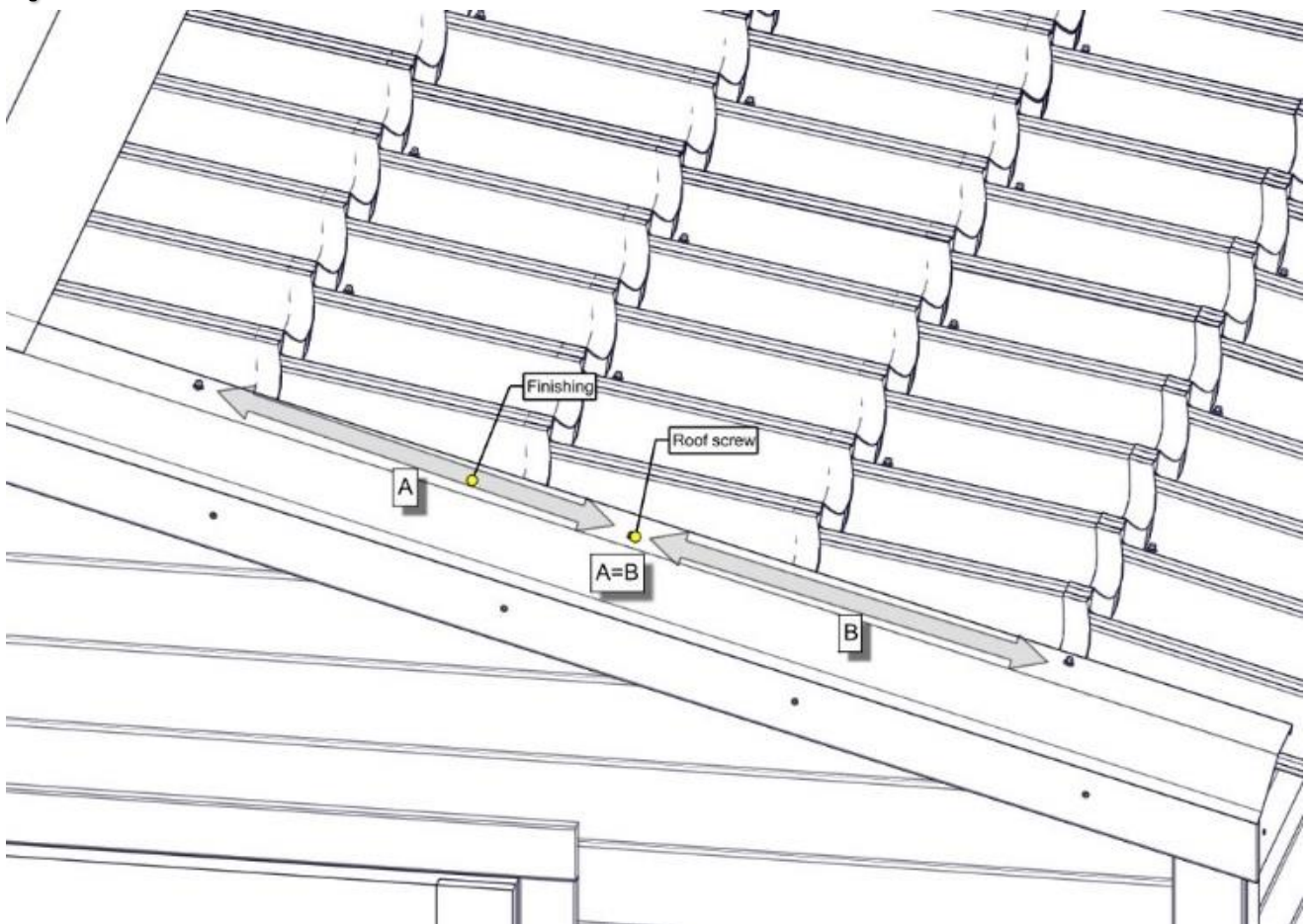

51/61

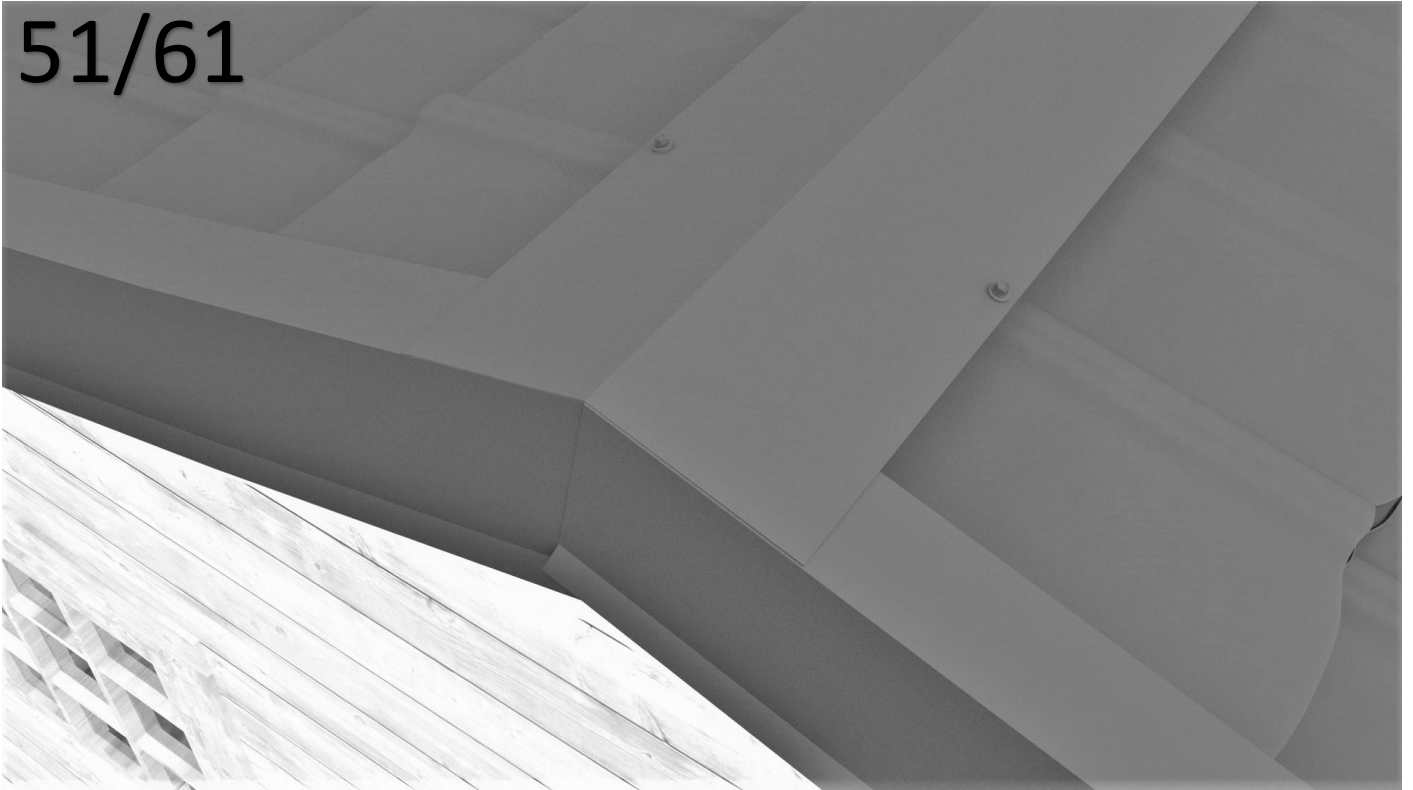

52/61



53/61

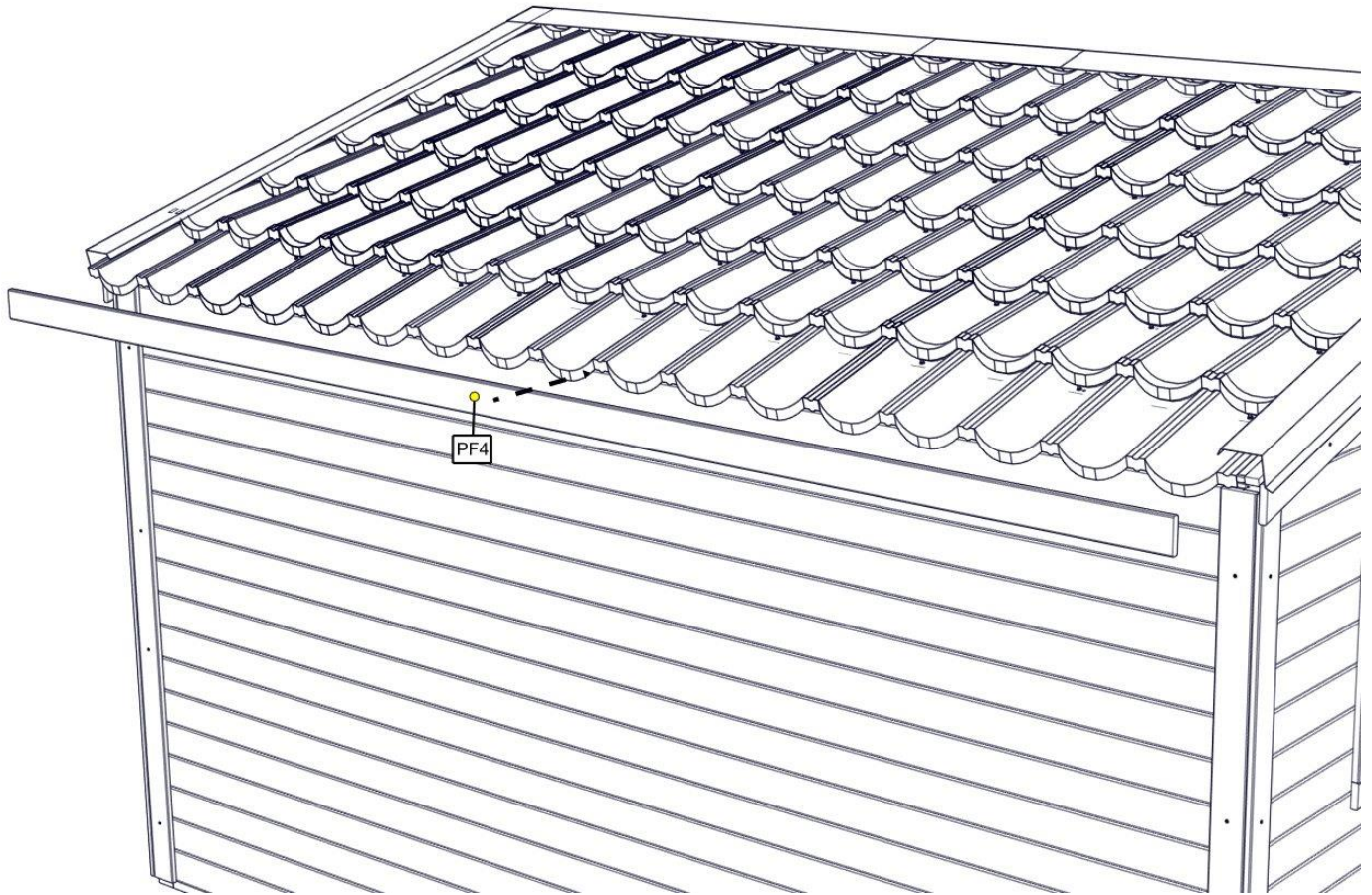

54/61

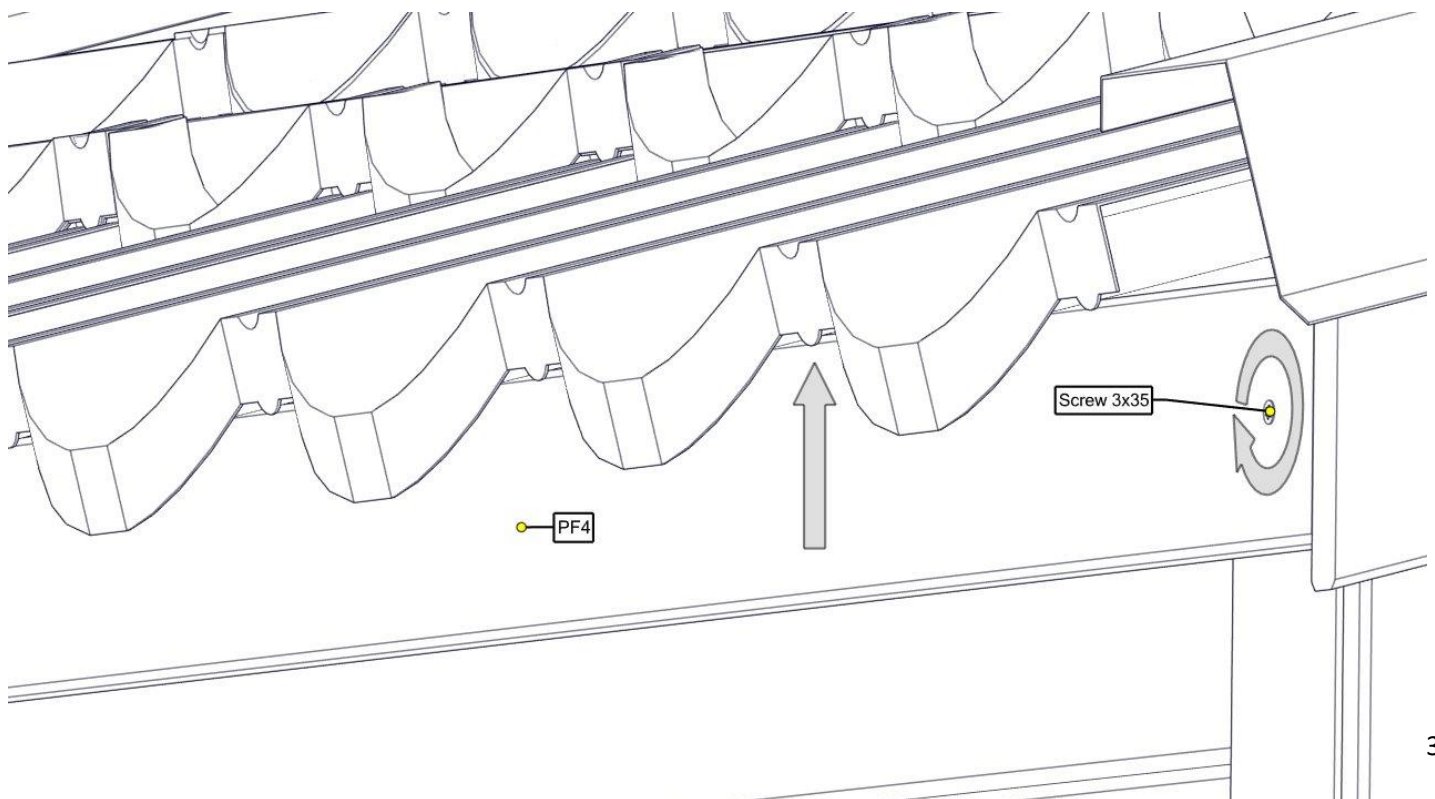

55/61

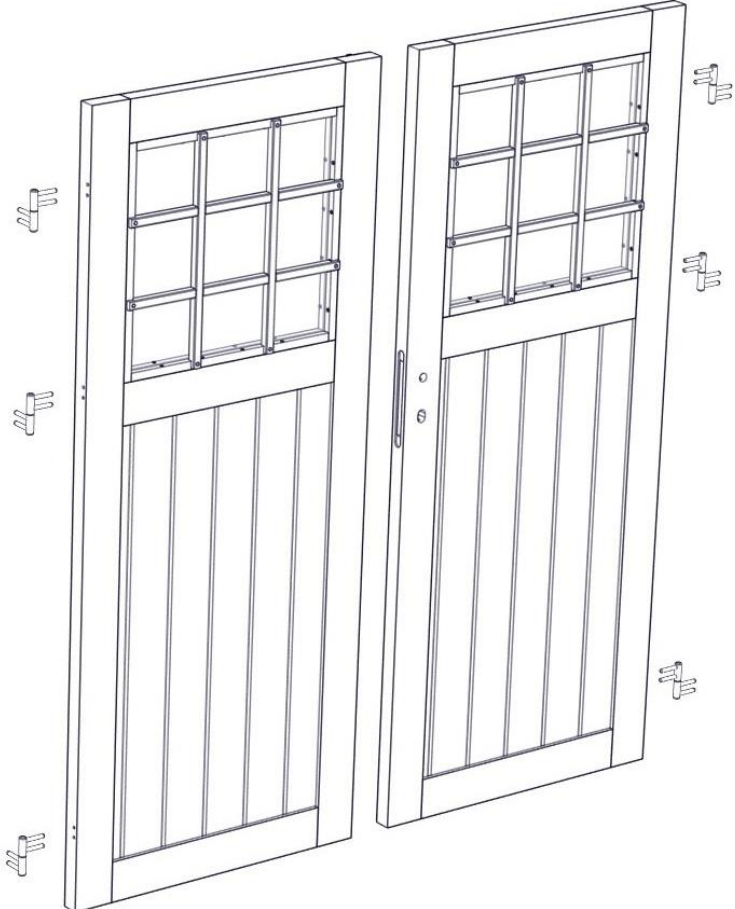

56/61

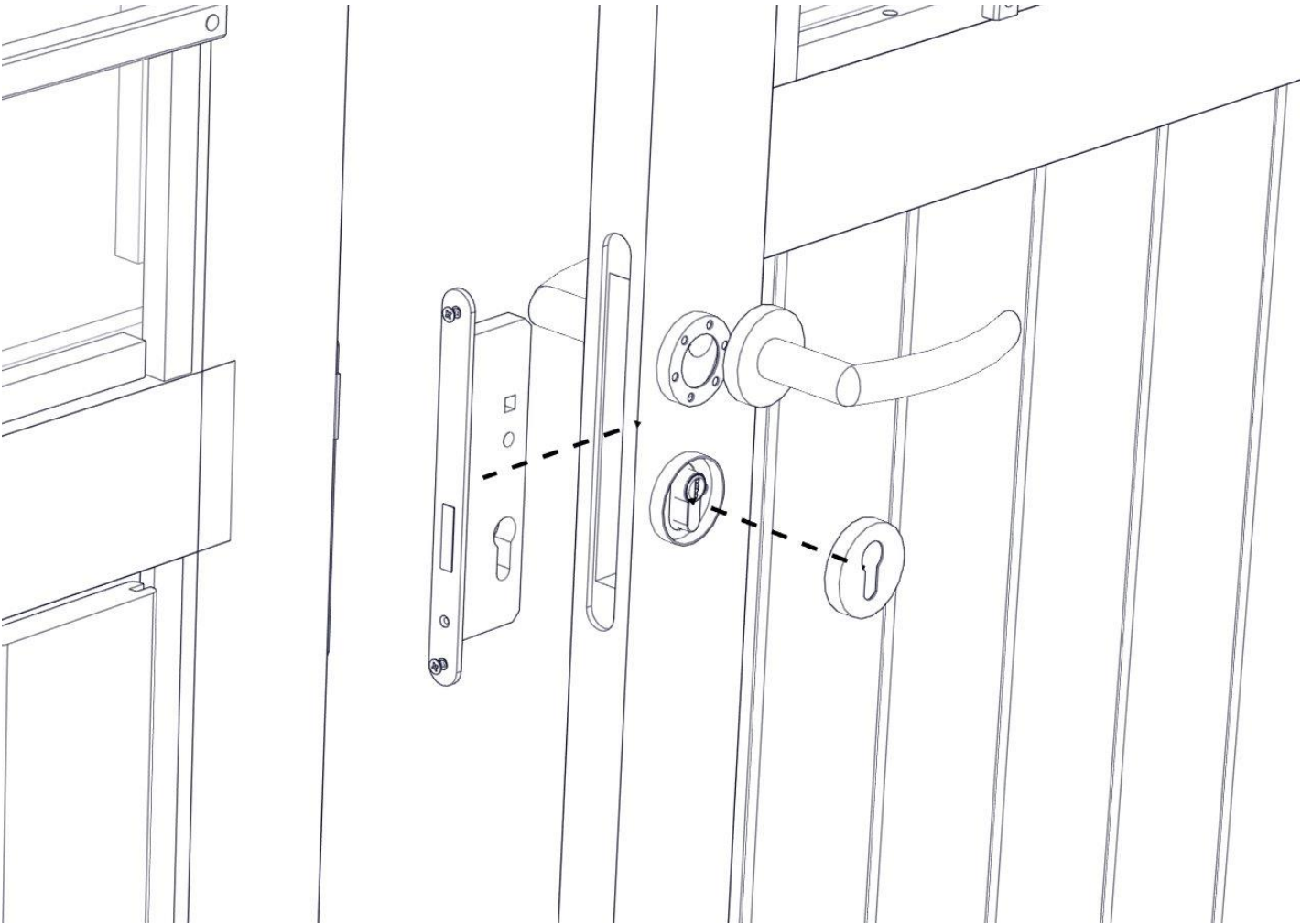

57/61

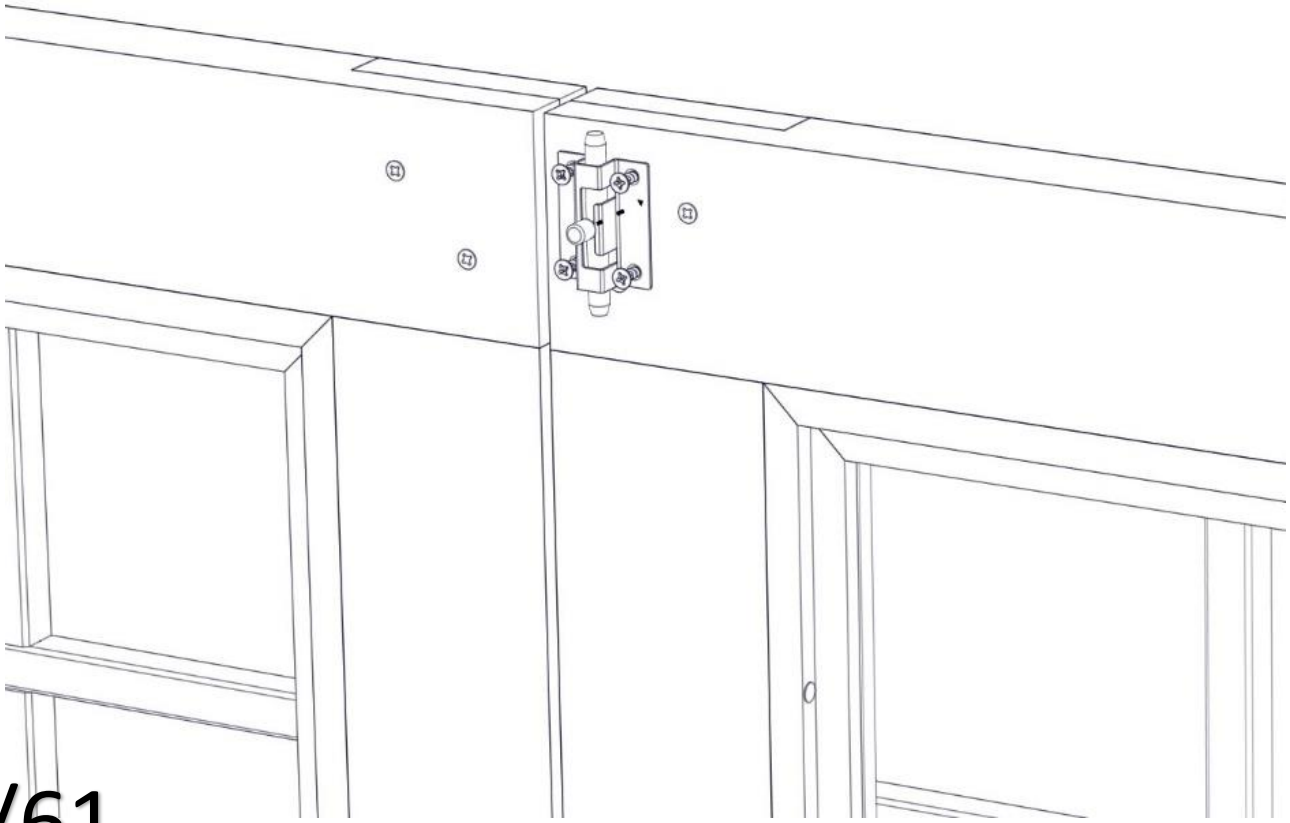

58/61

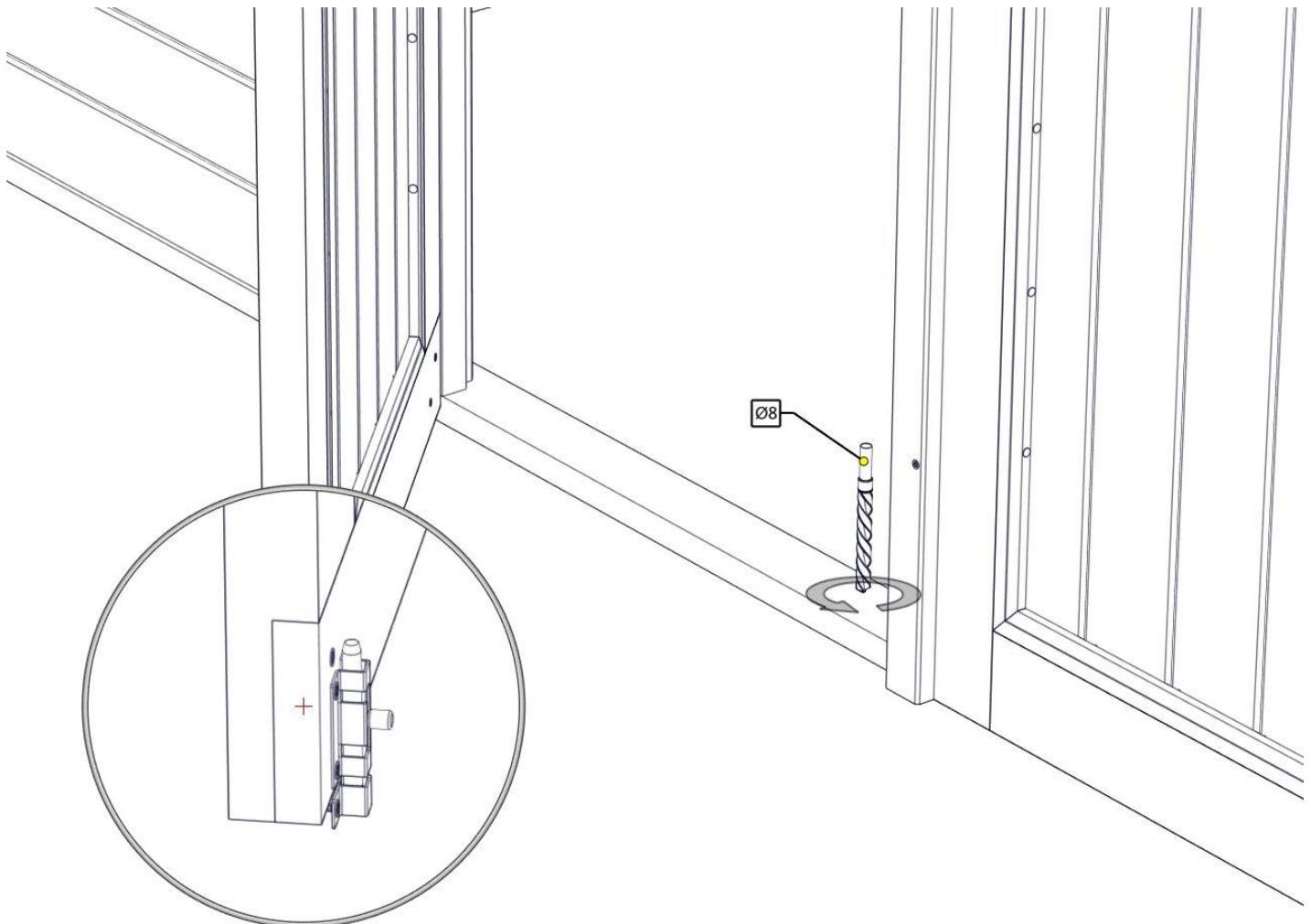

59/61

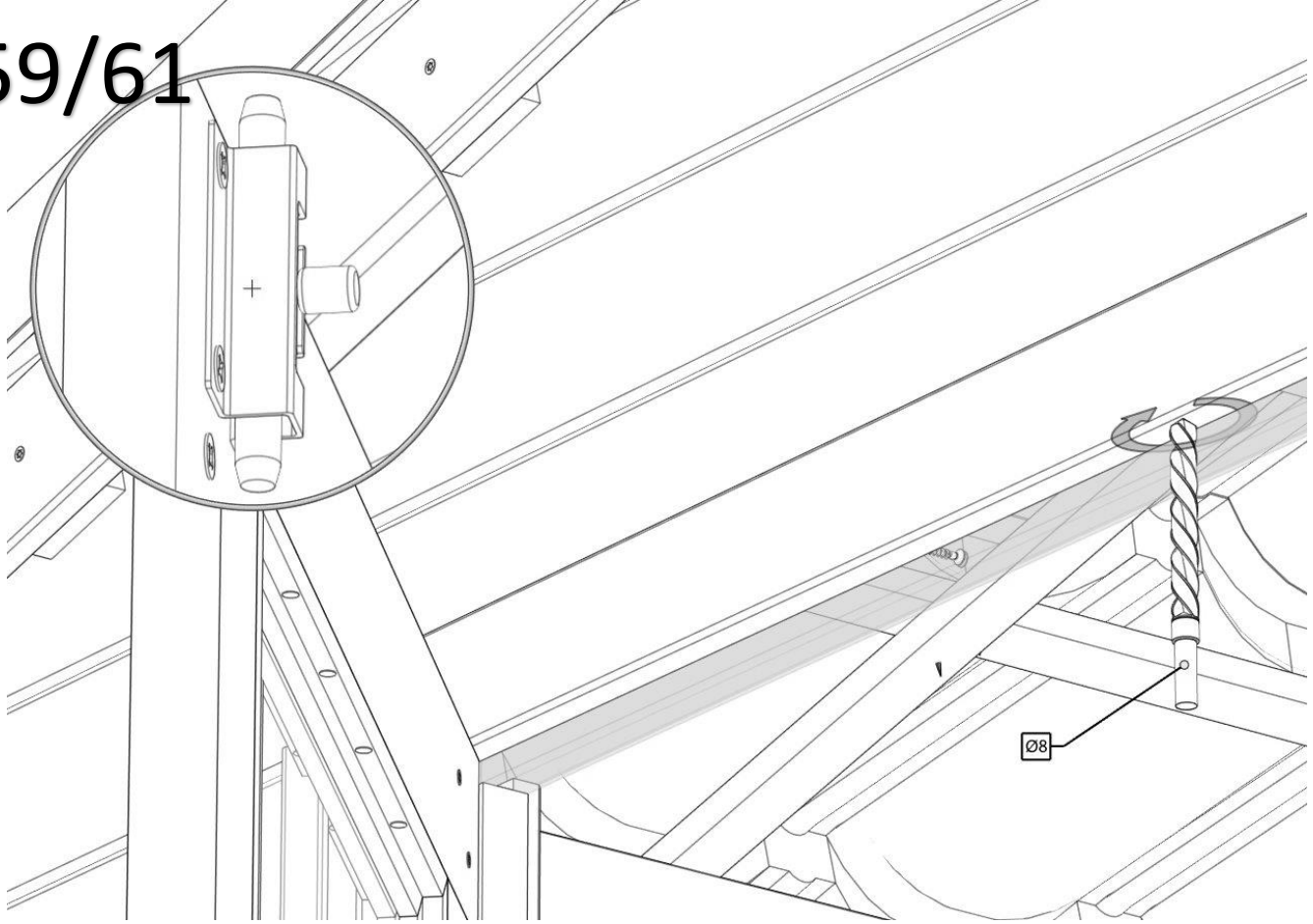

60/61

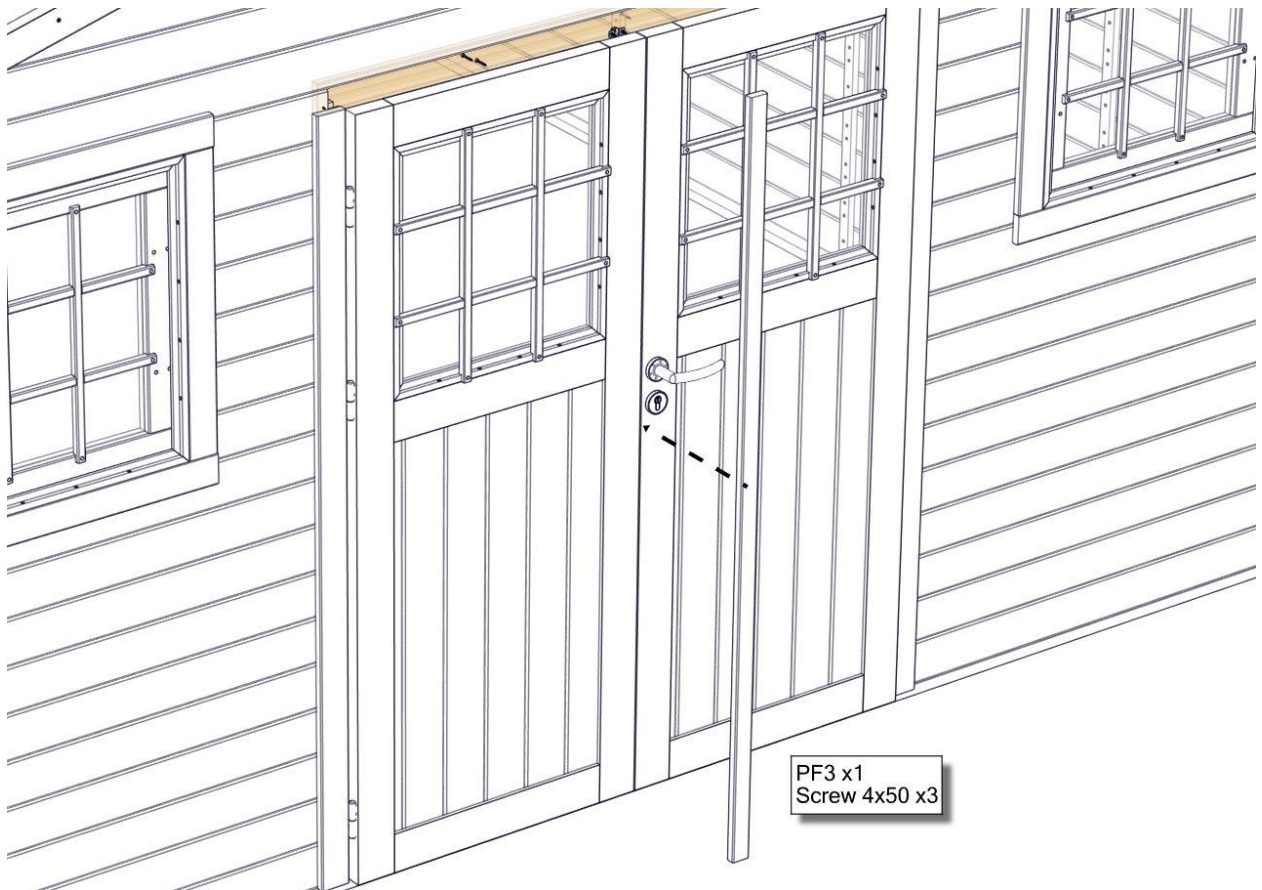

61/61

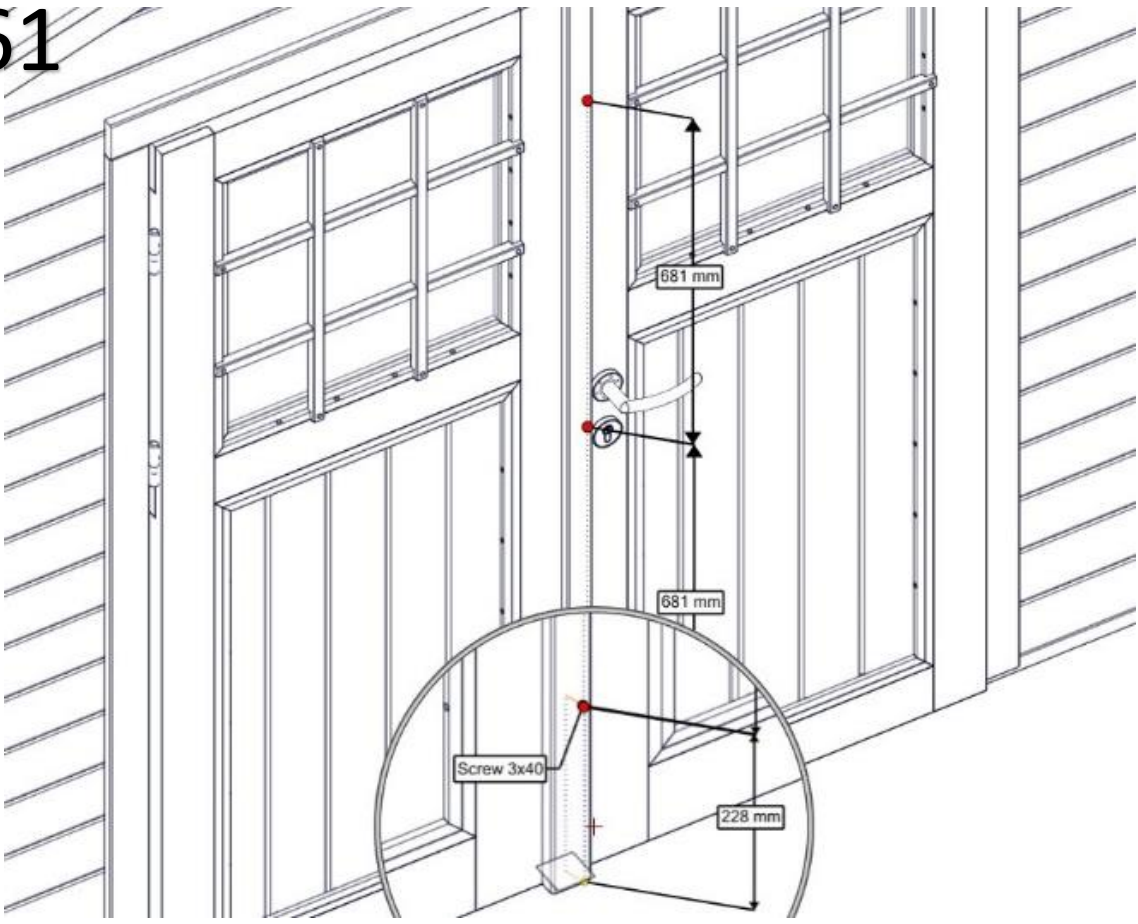



Cerland
OUTDOOR COLLECTION